



# Alfresco Kitchen Collection



Technik für Möbel

  
**Hettich**

There's so much more to outdoor living than simply lighting up a barbecue.

By bringing the style, comfort, and conveniences of an indoor kitchen into your outside space, you'll be able to prepare and cook all kinds of delicious food while entertaining friends and family under the glow of sunlight, surrounded by natural beauty.

With potentially limitless functions, from sinks and fridges to innovative storage space, outdoor kitchens can come in all shapes and sizes to suit your space and design taste – giving you everything on hand to host a meal without moving inside. Using Hettich's sophisticated and durable fittings, you'll enjoy peace of mind that your outdoor kitchen will function exactly as you need for years to come, withstanding the harsh Australian sun, wind, and rain.

#### **Publisher's imprint**

© Hettich Australia  
6 Entolasia Close  
Kemps Creek NSW 2178

Free Phone: 1800 687 789  
Instagram @hettichaustralia  
support@hettich.com.au  
<https://web.hettich.com/en-au/home>

We reserve all rights to this catalogue under copyright law. It shall not be permissible to duplicate this catalogue in any form either in whole or in part without our written consent. Subject to technical alterations. Errors and omissions excepted. Subject to colour variations.

February 2023  
Order no.: 9307683

## Outdoor living in style.



### Top trends in outdoor kitchens

**Functional zones.** The best outdoor kitchens offer ease of navigation and flow between work zones, such as placing storage cabinets near cooking areas and your fridge and sink near the preparation area and worktop.

**Cooking versatility.** Having an outdoor kitchen is your opportunity to explore new and exciting ways of cooking that you can't do inside. Smokers, pizza ovens, and open flame cooking are popular inclusions in outdoor kitchens.

**Bringing indoor style, outdoors.** High quality modern materials and fittings allow you to invite the same warmth and functionality of your home interior into your garden, from deep pull-out drawers with natural tone facades to sleek handles and ambient lighting – anything is possible.

**Integrated social areas.** If you're outside preparing a meal, you'll need a comfortable space for your family and guests to relax nearby. An open plan layout is a popular choice, designing functional areas around a dining table or cosy seating space – you could even incorporate an outdoor fireplace.

## InnoTech Atira double walled drawer system – The adaptive and flexible system for all market segments.

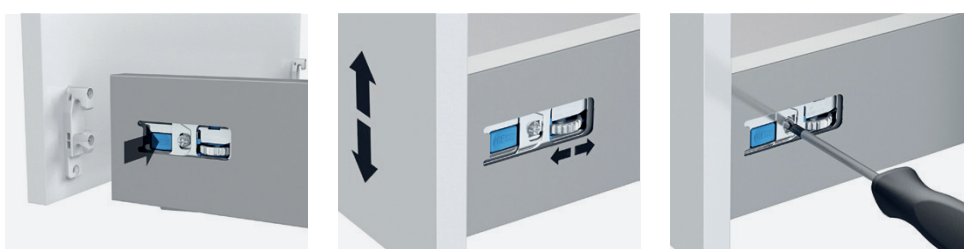

The InnoTech Atira drawer system by Hettich is designed with the potential for individual creativity in mind. With a focus on the systems sharp contours. The system features Anthracite in the Outdoor Alfresco Kitchen Collection with a range of side element heights of 70mm, 144mm & 176mm. The full extension Quadro Compact runners have a loading capacity of 40 kg and is available in soft closing.

**Note:** The InnoTech Atira Drawer System is not made from stainless steel and therefore subject to rust or discoloration if exposed to salt air and water.

## Running true to form – Quadro Compact ball bearing runner system



Ball bearings are one of the world's success stories. High-performance and precision machines would be unthinkable without them. Ball bearings are precision components that deliver the smoothest possible action and enjoy an extremely long life. And they are virtually indestructible, coping with big temperature fluctuations and tremendous loads.

Runner elements in Alfresco Outdoor Kitchens work hard, often in the most difficult conditions. If you are looking for a tough runner system capable of delivering peak performance and of coping with a heavy workload, there is nothing to beat a system based on the ball bearing idea – the Quadro runner system. The Quadro Compact runner includes all the benefits and features Hettich's Quadro system has to offer and more. It has been specifically modified to be used with InnoTech Atira and features the same drilling positions as compared to the standard Quadro runner. The Compact runner derives from the White goods family of runners used in refrigerators and built-in ovens hence the perfect option for use in outdoor kitchens – a lot more protected against corrosion.



# Double-walled drawer system InnoTech Atira Kits

▶ Powder-coated steel, anthracite

## Drawer set, height 70mm



Drawer set includes runner:

- ▶ Quadro Compact full extension runner, loading capacity 40 kg, left and right
- ▶ Drawer side profile, left and right
- ▶ Drawer front connection for side profile, 2 each
- ▶ Cover cap, 2 each
- ▶ Rear panel connector, left and right

Nominal length mm	Order no. Kit	PU
470	<b>9 308 037</b>	1 set

## Drawer set, height 144mm



Pot-and-pan drawer set with railing, includes runner:

- ▶ Quadro Compact full extension runner, loading capacity 40 kg, left and right
- ▶ Drawer side profile, left and right
- ▶ Drawer front connection for lengthwise railing, 2 each
- ▶ Lengthwise railing, 2 each
- ▶ Cover cap, 2 each
- ▶ Rear panel connector, left and right

Nominal length mm	Order no. Kit	PU
470	<b>9 308 039</b>	1 set

## Drawer set, height 176mm



Pot-and-pan drawer set with railing, includes runner:

- ▶ Quadro Compact full extension runner, loading capacity 40 kg, left and right
- ▶ Drawer side profile, left and right
- ▶ Drawer front connection for lengthwise railing, 2 each
- ▶ Lengthwise railing, 2 each
- ▶ Cover cap, 2 each
- ▶ Rear panel connector, left and right

Nominal length mm	Order no. Kit	PU
470	<b>9 308 040</b>	1 set

# InnoTech Atira double walled drawer system

- ▶ Drawer runner, Quadro Compact, for outdoors
- ▶ Full extension runner, load capacity 40 kg

## Quadro Compact with Silent System

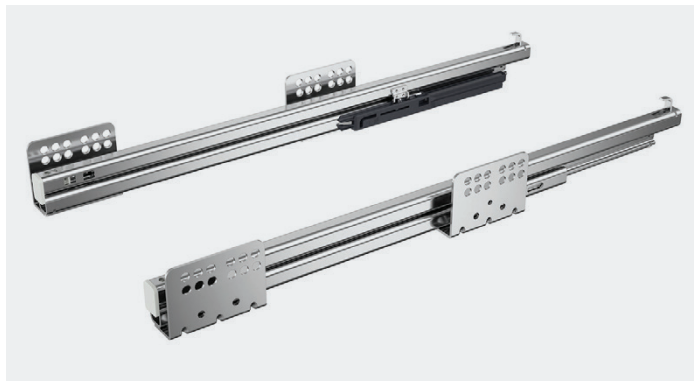

- ▶ With integrated Silent System
- ▶ Slide on installation
- ▶ Suitable for outdoor use in line with DIN EN 1670, class 3
- ▶ Load capacity to EN 15338, Level 3
- ▶ Custom finish

### Bulk packaging

Nominal length / drawer length NL mm	Order no. Silent System		PU
	left	right	
470	9 311 544	9 311 545	16 ea.

## Planning / installation dimensions

BB Bottom panel width	
BL Bottom panel length	
KB Cabinet width	
RB Rear panel width	
NL Nominal length	
KD Cabinet panel thickness	
LB Internal width	
LT Internal depth	
EB Installation width	

KD	16		
EB	12,5	10,5	9,5
A	23	21	20

Dimension	mm
BL	480
BB	LB - 76.5 mm
RB	LB - 88 mm

## Side cross section

Silent System

NL	KT	b1
470	485	256

NL Nominal length	
KT Cabinet depth	

# OrgaTray 490

## ▶ InnoTech Atira drawer systems

### OrgaTray 490 for InnoTech Atira



- ▶ Can be used from cabinet width of 450 mm
- ▶ Two trays can be fitted in a cabinet width starting from 800 mm
- ▶ Height 49 mm
- ▶ Plastic
- ▶ It is recommended to fit an anti-slip mat

### OrgaTray 490 for InnoTech Atira

Depth mm	Order no. / colour   Width 450 mm	PU
470	9 207 246 anthracite	1 ea

### Divider OrgaTray 490

NL 470	D 462		NL 520	D 512	
W	324		W	324	
CW	450		CW	450	

NL = Nominal length    D = Depth    W = Width    CW = Cabinet width



# OrgaTray 590

## ► InnoTech Atira drawer systems

### OrgaTray 590 for InnoTech Atira



- Nominal length 470 mm
- Suitable for standard cabinet width
- Plastic
- Height 55 mm

### OrgaTray 590 for InnoTech Atira

Width mm	Order no. / colour   Depth 470 mm anthracite	PU
300	9 194 908	1 ea
400	9 194 909	1 ea
450	9 194 910	1 ea
500	9 194 911	1 ea
600	9 194 913	1 ea
800	9 194 914	1 ea
900	9 194 915	1 ea
1000	9 194 916	1 ea.

### Partitioning

470	462									
<b>W</b>	207	307	357	407	457	507	707	807	907	
<b>CW</b>	300	400	450	500	550	600	800	900	1000	

NL = Nominal length    D = Depth    W = Width    CW = Cabinet body width

# Double-walled drawer system InnoTech Atrra

## ► Narrow base unit



- Suitable for cabinet width min. 150 and max. 300 mm
- Stability through diagonally mounted runners (left / right)
- Load capacity up to 20kg

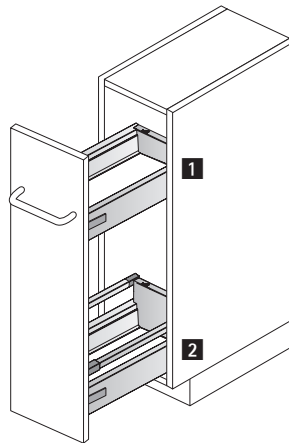

### Example application

**H70**

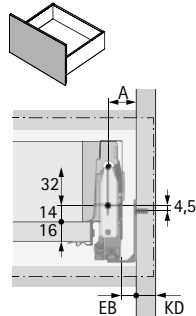
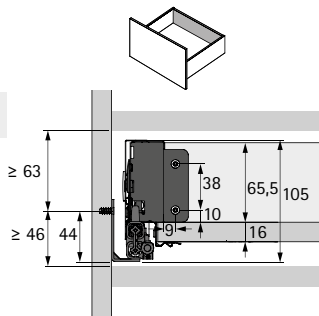

**H144**

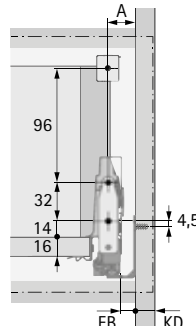
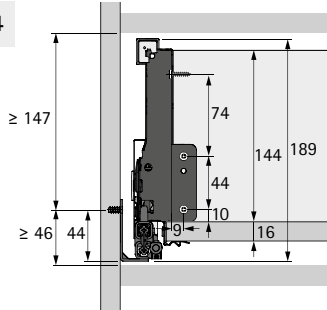

Set comprises:

- 2 Drawer side profiles, left and right
- 4 Rear panel connectors, left and right
- 1 Lengthwise railing, left and right
- 4 Drawer front connectors for drawer side profile with expanding dowel
- 2 Drawer front connectors for lengthwise railing with expanding dowel
- 4 Cover caps, anthracite plastic with Hettich logo
- 1 Drawer runner Quadro Compact with Silent System, left and right

Nominal length mm	Order no.	PU
470	9 306 833	1 set

# Fast assembly concealed hinge

- ▶ Veosys 105° Stainless steel hinge
- ▶ 105° opening angle, drilling pattern TH 52 x 5.5 mm

## Veosys 105° Stainless steel hinge



- ▶ Concealed hinge with clip on installation and integrated Silent System
- ▶ Quality classification under EN 15570, Level 2
- ▶ Corrosion proof, 120h NSS (neutral salt spray test) to DIN EN ISO 9227
- ▶ For door thickness of 14 - 22 mm
- ▶ Cup diameter 35 mm
- ▶ Cup depth 11.5 mm
- ▶ Integrated overlay adjustment + 2.5 mm / - 2.5 mm
- ▶ Integrated depth adjustment + 2 mm / - 1.5 mm
- ▶ Height adjustment at mounting plate
- ▶ Stainless steel

<p>Drilling pattern</p>	<p>full overlay (Base B 11.5 mm)</p>	<p>half overlay (Base B 3 mm)</p>	<p>inset (Base B -6.5 mm)</p>
-------------------------	--	---------------------------------------	-----------------------------------

## With integrated Silent System, with self closing feature

Cup assembly	Mounting hole $\varnothing \times T$ mm	full overlay	half overlay	inset
for screwing on	-	200 ea. 9 289 590	200 ea. 9 289 592	200 ea. 9 289 595

# Fast assembly concealed hinge

- ▶ Stainless steel mounting plates with oblong hole height adjustment
- ▶ For Veosys

## Cross mounting plate for screwing on

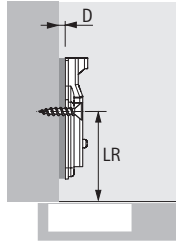

- ▶ For 4.5 mm  $\varnothing$  x 16 mm countersunk screws
- ▶ Quality classification under EN 15570, Level 2
- ▶ Hole spacing 32 mm
- ▶ Oblong hole height adjustment  $\pm 3$  mm
- ▶ Stainless steel

Hole line distance LR mm	Order no. / Distance D mm		PU
	0.0	2.0	
37	9 289 598	9 289 609	200 ea.

## Veosys cup spacer

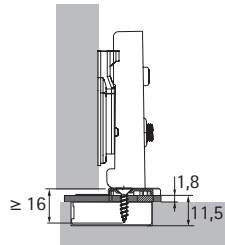

- ▶ To reduce the required depth of the cup drilling for thin door materials
- ▶ Thickness of cup spacer 1.8 mm
- ▶ Plastic, transparent

Order no.	PU
9 306 263	50 ea.

## Fixing screw for Veosys hinge cup



- ▶ 6G x 5/8 stainless steel fixing screw for Veosys hinge cup

Order no.	PU
9 308 933	200 pcs.

## Cover cap for Veosys hinge arm



- ▶ Suitable for use with Veosys
- ▶ Stainless steel

Version	Order no.	PU
embossed with Hettich logo	9 289 610	200 ea.
neutral	9 289 611	200 ea.

**Note:** The Veosys Stainless Steel hinge has been corrosion proof tested for 120 hours in a neutral salt spray and the hinge is made from stainless steel material grade S 304.

# Fast assembly concealed hinge

- ▶ Veosys 105° Stainless steel hinge
- ▶ 105° opening angle

## Minimum reveal per door

Door thickness mm	Cup distance C mm				
	3.0	4.0	5.0	6.0	7.0
14	0.3	0.3	0.2	0.2	0.2
15	0.5	0.5	0.4	0.4	0.4
16	0.7	0.7	0.6	0.6	0.5
17	0.9	0.9	0.9	0.8	0.8
18	1.2	1.1	1.1	1.1	1.0
19	1.5	1.4	1.4	1.3	1.3
20	1.8	1.8	1.7	1.6	1.6
21	2.2	2.1	2.0	2.0	1.9
22	2.6	2.5	2.4	2.4	2.3

Note:

The values in the table refer to doors with an edge radius of 1 mm.

On doors with other radii, the minimum reveal changes as follows:

Radius 0 mm:  
Values in table + 0.4 mm

Radius 3 mm:  
Values in table - 0.6 mm

## Protrusions / installed depth

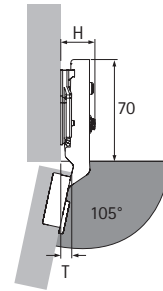

Hinge protrusion H / door protrusion T for distance D = 0 mm and cup distance C = 3 mm

Door mounting option	H mm	T mm
full overlay	20.0	7.5
half overlay	30.0	17.0
inset	37.0	24.0

## full overlay

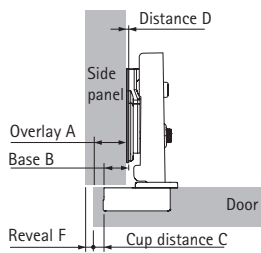

$$\text{Distance D} = \text{C} + \text{B} - \text{A}$$

$$= \text{cup distance C} + 11.5 \text{ mm} - \text{overlay A}$$

Overlay mm	Cup distance C mm				
	3.0	4.0	5.0	6.0	7.0
Distance D mm					
10	4.5	5.5	6.5	7.5	8.5
11	3.5	4.5	5.5	6.5	7.5
12	2.5	3.5	4.5	5.5	6.5
13	1.5	2.5	3.5	4.5	5.5
14	0.5	1.5	2.5	3.5	4.5
15		0.5	1.5	2.5	3.5
16			0.5	1.5	2.5
17				0.5	1.5
18					0.5

## half overlay

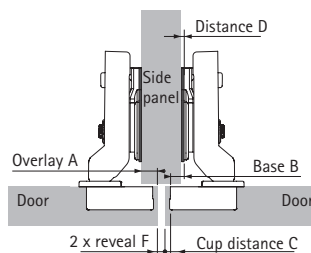

$$\text{Distance D} = \text{C} + \text{B} - \text{A}$$

$$= \text{cup distance C} + 3 \text{ mm} - \text{overlay A}$$

Overlay mm	Cup distance C mm				
	3.0	4.0	5.0	6.0	7.0
Distance D mm					
0.5	5.5	6.5	7.5	8.5	9.5
1.5	4.5	5.5	6.5	7.5	8.5
2.5	3.5	4.5	5.5	6.5	7.5
3.5	2.5	3.5	4.5	5.5	6.5
4.5	1.5	2.5	3.5	4.5	5.5
5.5	0.5	1.5	2.5	3.5	4.5
6.5		0.5	1.5	2.5	3.5
7.5			0.5	1.5	2.5
8.5				0.5	1.5
9.5					0.5

## inset

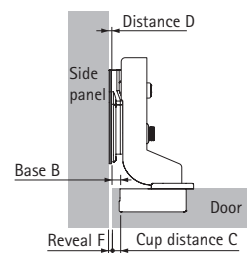

$$\text{Distance D} = \text{C} + \text{B} + \text{F}$$

$$= \text{cup distance C} - 6.5 \text{ mm} + \text{reveal F}$$

Door thickness mm	Cup distance C mm				
	3.0	4.0	5.0	6.0	7.0
Distance D mm					
14				0.7	
15				0.9	
16			0.1	1.0	
17			0.3	1.3	
18			0.6	1.5	
19			0.8	1.8	
20		0.2	1.1	2.1	
21		0.5	1.5	2.4	
22	0.0	0.9	1.9	2.8	

# Waste Collecting Systems

## ► For InnoTech Atira drawer systems

### InnoTech Atira Pull



- Top running waste collecting system for InnoTech Atira drawer, 70 mm high
- The InnoTech Pull frame is used instead of the drawer bottom panel
- Frame can be equipped as required with various bins and accessories
- Please order bin separately
- Please order InnoTech Atira drawer components separately
- Powder coated steel, anthracite

Set comprises:

- 1 fitted frame including front stay and lid
- Fixing material

For Cabinet width width mm	Type	Capacity	Order no. / Depth mm	PU
			470	
400	IT Pull 37 l / anthracite	1 x 29 l / 1 x 8 l	9 304 683	1 set
450	IT Pull 34 l / anthracite	2 x 17 l	9 304 684	1 set
450	IT Pull 58 l / anthracite	2 x 29 l	9 304 685	1 set
500	IT Pull 34 l / anthracite	2 x 17 l	9 304 686	1 set
500	IT Pull 58 l / anthracite	2 x 29 l	9 304 687	1 set
600	IT Pull 74 l / anthracite	2 x 29 l / 2 x 8 l	9 304 688	1 set
600	IT Pull 80 l / anthracite	2 x 40 l	9 304 689	1 set

### Planning dimensions

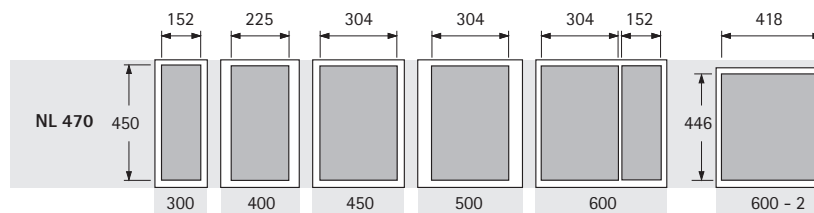

NL = Nominal length CW = Cabinet width

# ComfortSpin

- ▶ Revolving tray, Plastic, transparent

## ComfortSpin



- ▶ Turntable for filling and optimising use of storage space
- ▶ For use in refrigerators or furniture
- ▶ Including Fixing material
- ▶ Plastic, transparent or anthracite finish

Colour	Order no.	PU
anthracite	9 325 329	1 ea.
transparent	9 325 328	1 ea.

# ProDecor Handles

## ► New Modern Collection

### Salvia

### Guarani



Brushed stainless steel

Brushed stainless steel

•••			□
96	157	9 071 003	50
128	188	9 071 005	50
160	220	9 071 008	50
256	316	9 071 017	50
352	412	9 071 023	20
448	508	9 071 026	20

•••			□
128	149	9 208 046	40
160	181	9 208 047	50
194	223	9 208 048	50
244	259	9 208 049	50

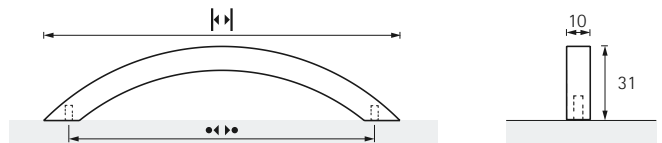
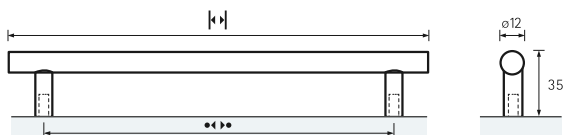

**Note:** The listed ProDecor handles are a S 304 grade stainless steel.



# Shadowline

## ► Profile aluminium



1 52mm Shadowline Handle  
clear anodised



2 52mm Shadowline Handle  
black brushed



3 52mm Shadowline Handle  
white powder coated

	☒		☐
1	52	9 995 910	4 
2	52	9 282 235	4
3	52	9 282 237	4

For additional information please use our ProDecor handle catalogue.



## Versa SuperPlus

### Advantages

- Evenly illuminated area
- Lateral bending direction (see drawing)
- Flush mounting possible
- Can be individually cut to size

### Features

- Protection against water jets from all directions (IP 65)
- Suitable for damp locations
- Supply lead on both sides (one cut, two lights), see drawing

### Examples of use

- Round counters
- Decorative surfaces with visible curves
- Particularly narrow cabinet interior lighting

### Order information

- Packaging unit consists of 1 piece Versa, 2 end caps and a silicone tube for sealing in wet room applications

### Versa Super Plus

	WarmWhite
2500 mm (max. 18.8 W)	55 815 11

### Accessories\*

LED ballast 15 W with Australia plug	31 026 01
LED ballast 30 W with Australia plug	30 221 01
MP2 2-way distributor	39 422 51
MP2 6-way distributor	36 996 01

### Technical details



Luminaire type:	Surface-mounted light
Type of lighting:	Accent lighting
Operating voltage:	24 V DC
Light colours:	WarmWhite
Colour rendering:	RA >80
Luminous flux:	400 lm/m
Light source efficiency:	53 lm/W
Life span:	40,000 h (L70)
Power consumption:	7.5 W/m
Max. length at a stretch:	5 m
Dimmable:	Yes/PWM/Smart.home
Beam angle:	120°
Half value angle:	70°
Test marks and symbols:	CE ENEC VDE
Protection rating:	IP 65 (Only in the gated area)
Supply lead:	2 x 1800 mm
Plug connector:	LED MultiPlug MP2 (max. 192 W)
Connection to:	LED ballast

# Magic Lighting

## ► Versa SuperPlus Mini



## Versa SuperPlus Mini

### Advantages

- Evenly illuminated area
- Lateral bending direction (see drawing)
- Flush mounting possible
- Can be individually cut to size

### Features

- Protection against water jets from all directions
- Suitable for damp locations (IP 44)
- Supply lead on both sides (one cut, two lights), see drawing

### Examples of use

- Round counters
- Decorative surfaces with visible curves
- Particularly narrow cabinet interior lighting

### Versa Super Plus Mini

	WarmWhite	NeutralWhite
1200 mm (max. 7.2 W)	55 864 12	55 864 02
5000 mm (max. 30 W)	55 864 13	55 864 03

### Accessories\*

LED ballast 15 W with Australia plug	31 026 01
LED ballast 30 W with Australia plug	30 221 01
M1 extension lead 1800 mm	36 768 01
M1 3-way distributor 180 mm	36 852 01

### Technical details



Luminaire type:	LED surface-mounted/ recessed light
Type of lighting:	Accent lighting
Operating voltage:	12 V DC
Light colours:	WarmWhite/ NeutralWhite
Colour rendering:	RA >80
Luminous flux:	150 lm/m
Luminaire efficiency:	25 lm/W
Light source efficiency:	115 lm/W
Life span:	40,000 h (L70)
Power consumption:	6 W/m
Max. length at a stretch:	5 m
Dimmable:	Yes/PWM/Smart.home
Beam angle:	120°
Half value angle:	70°
Test mark and symbols:	CE ENEC VDE
Protection rating:	IP 44 (Only in the gated area)
Supply lead:	2 x 1800 mm
Plug connector:	LED mini M1 plug connector
Connection to:	LED ballast



Order number 9307683

Technik für Möbel

