



Internal Organisation

Technik für Möbel

Hettich

OrgaTray 470 / 490

For AvanTech YOU / ArciTech / InnoTech Atira drawer systems

Drawer Organisation:

Plastic

- ▶ Can be used from cabinet body width of 450 mm
- ▶ 2 can be fitted in cabinet bodies in widths of 800 mm and over
- ▶ Height 49 mm
- ▶ Plastic
- ▶ It is recommended to fit an anti-slip mat



Silver



White



Anthracite

OrgaTray 470 for AvanTech YOU and ArciTech

Depth mm	Order no. / colour Width 450 mm			PU
	silver	white	anthracite	
500	9 207 220	9 207 224	9 207 227	1 ea.
550	9 207 222	9 207 226	9 207 238	1 ea.

OrgaTray 490 for Innotech Atira

Depth mm	Order no. / colour Width 450 mm			PU
	silver	white	anthracite	
470	9 207 241	9 207 243	9 207 246	1 ea.
520	9 207 242	9 207 245	9 207 247	1 ea.

Divider OrgaTray 470

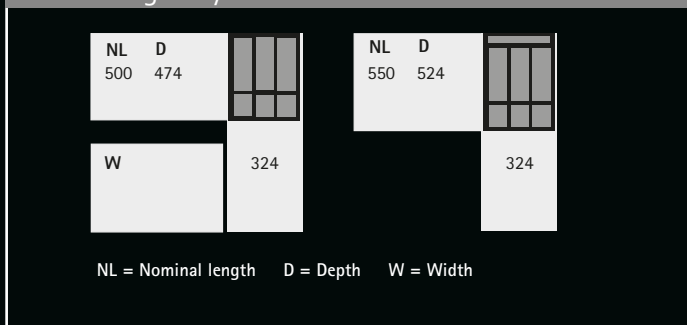

Divider OrgaTray 490

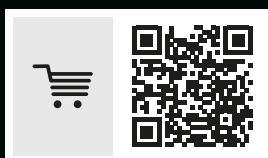
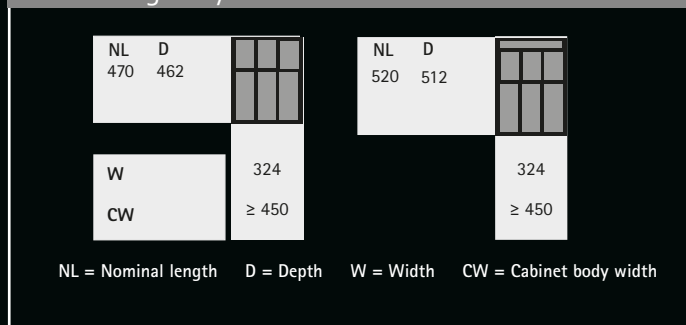

hettich.com/short/13b753

OrgaTray 590

For InnoTech Atira drawer systems

Drawer Organisation:

Plastic



- ▶ Nominal length 470 mm
- ▶ Suitable for standard cabinet width
- ▶ Plastic
- ▶ Height 55 mm



Silver



White



Anthracite

OrgaTray 590 for InnoTech Atira

Width mm	Order no. / colour Depth 470 mm			PU
	silver	white	anthracite	
300	9 194 886	9 194 897	9 194 908	1 ea.
400	9 194 887	9 194 898	9 194 909	1 ea.
450	9 194 888	9 194 899	9 194 910	1 ea.
500	9 194 889	9 194 900	9 194 911	1 ea.
600	9 194 891	9 194 902	9 194 913	1 ea.
800	9 194 892	9 194 903	9 194 914	1 ea.
900	9 194 893	9 194 904	9 194 915	1 ea.
1000	9 194 894	9 194 905	9 194 916	1 ea.

Partitioning

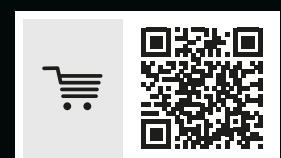
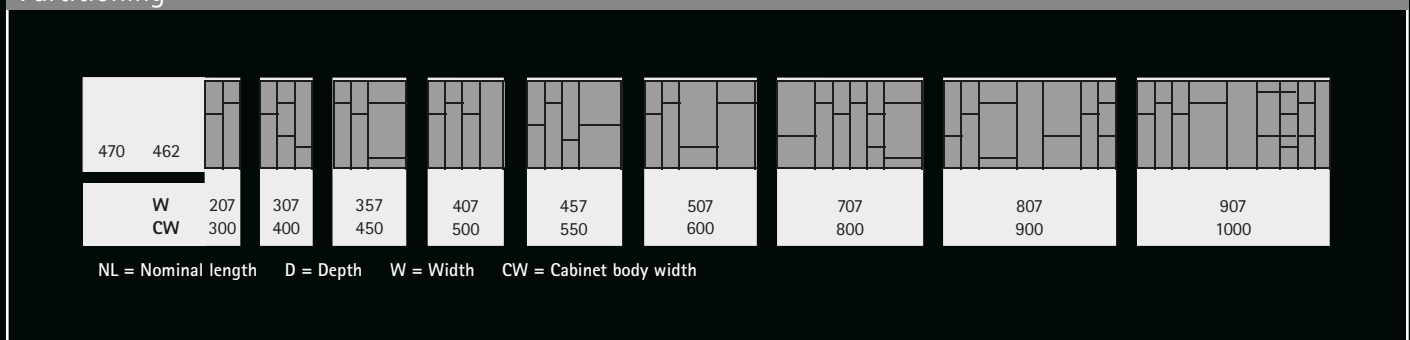

hettich.com/short/55b867

OrgaTray 440

For ArciTech / InnoTech Atira drawer systems

Drawer Organisation:

Plastic



- ▶ Can be used for ArciTech drawer height 94 mm and IT Atira drawer height 70 mm
- ▶ Height 55 mm
- ▶ Plastic



Silver



White



Anthracite

OrgaTray 440 for ArciTech and InnoTech Atira

Width mm	Order no. / colour Depth 380 – 440 mm			PU
	silver	white	anthracite	
201 – 250	9 194 918	9 194 949	9 194 980	1 ea.
251 – 300	9 194 919	9 194 950	9 194 981	1 ea.
301 – 350	9 194 920	9 194 951	9 194 982	1 ea.
351 – 400	9 194 921	9 194 952	9 194 983	1 ea.
401 – 450	9 194 922	9 194 953	9 194 984	1 ea.
451 – 500	9 194 923	9 194 954	9 194 985	1 ea.
501 – 600	9 194 924	9 194 955	9 194 986	1 ea.
601 – 700	9 194 925	9 194 956	9 194 987	1 ea.
701 – 800	9 194 926	9 194 957	9 194 988	1 ea.
801 – 900	9 194 927	9 194 958	9 194 989	1 ea.
901 – 1000	9 194 928	9 194 959	9 194 990	1 ea.
1091 – 1150	9 194 929	9 194 960	9 194 991	1 ea.

Width mm	Order no. / colour Depth 441 – 520 mm			PU
	silver	white	anthracite	
201 – 250	9 194 931	9 194 962	9 194 993	1 ea.
251 – 300	9 194 932	9 194 963	9 194 994	1 ea.
301 – 350	9 194 933	9 194 964	9 194 995	1 ea.
351 – 400	9 194 934	9 194 965	9 194 996	1 ea.
401 – 450	9 194 935	9 194 966	9 194 997	1 ea.
451 – 500	9 194 936	9 194 967	9 194 998	1 ea.
501 – 600	9 194 937	9 194 968	9 194 999	1 ea.
601 – 700	9 194 938	9 194 969	9 195 000	1 ea.
701 – 800	9 194 939	9 194 970	9 195 001	1 ea.
801 – 900	9 194 940	9 194 971	9 195 002	1 ea.
901 – 1000	9 194 941	9 194 972	9 195 003	1 ea.
1091 – 1150	9 194 942	9 194 973	9 195 004	1 ea.

Divider

D	Diagrammatic representation of divider configurations for various widths and depths.										
D	Diagrammatic representation of divider configurations for various widths and depths.										
W	201-250	251-300	301-350	351-400	401-450	451-500	501-600	601-700	701-800	801-900	1091-1150
NW	Nominal width values for each width range.										
ArciTech	350	400	450	500	550	600	700	800	900	1000	1200
InnoTech Atira	300	350	400	450	500	550	600	700	800	900	1200

* = knife and spice rack can be incorporated

D = Depth W = Width NW = Nominal width

Knife holder and spice rack

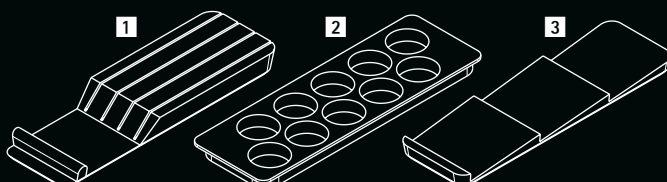

▶ Beech, lacquered

Article	Order no.	PU
1 Knife holder	0 074 430	1 ea.
2 Spice rack, standing, ø 53 mm	0 044 934	1 ea.
3 Spice rack, lying flat	9 079 207	1 ea.

OrgaTray 570

For ArciTech drawer systems

Drawer Organisation:

Plastic



- ▶ Suitable for standard cabinet width
- ▶ ArciTech drawer height 94 mm
- ▶ Dividers are included (quantity depends on tray size)
- ▶ Height 55 mm
- ▶ Plastic



Silver



White



Anthracite

OrgaTray 570 for ArciTech

Width mm	Order no. / colour Depth 500 mm			PU
	silver	white	anthracite	
400	9 134 977	9 135 015	9 183 328	1 ea.
450	9 134 979	9 135 016	9 183 329	1 ea.
500	9 134 980	9 135 017	9 183 330	1 ea.
550	9 134 991	9 135 018	9 183 331	1 ea.
600	9 134 992	9 135 019	9 183 332	1 ea.
800	9 134 993	9 135 020	9 183 333	1 ea.
900	9 134 994	9 135 031	9 183 334	1 ea.
1000	9 134 995	9 135 032	9 183 335	1 ea.

Divider

NL	D	Diagram showing divider configurations for various widths								
500	473	[Diagram showing various divider configurations for widths 400, 450, 500, 550, 600, 699, 799, 899]								
W	CW	299	349	399	449	499	699	799	899	
		400	450	500	550	600	800	900	1000	

NL = Nominal length D = Depth W = Width CW = Cabinet body width

Dividing elements



- ▶ For OrgaTray 570
- ▶ Plastic

Nominal length mm	Order no.		PU
	anthracite	white	
68	9 204 203	9 204 230	1/50 ea.
128	9 204 200	9 204 201	1/50 ea.

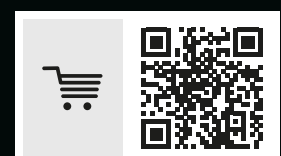

hettich.com/short/9dc998

OrgaTray 630

For AvanTech YOU / ArciTech / InnoTech Atira drawer systems

Drawer Organisation:

Steel



- ▶ Can be used from cabinet body width of 350 mm for AvanTech YOU and 400 mm for ArciTech or for InnoTech Atira
- ▶ 2 can be fitted in cabinet bodies in widths of 800 mm and over
- ▶ Can be combined with OrgaTray 270
- ▶ Height 43 mm
- ▶ Powder coated steel
- ▶ It is recommended to use a anti-slip mat



Silver



White



Anthracite

OrgaTray 630 for AvanTech YOU and ArciTech

Depth mm	Order no. / colour Width 270 mm			PU
	silver	white	anthracite	
450	9 278 315	9 278 331	9 278 318	1 ea.
500	9 278 316	9 278 332	9 278 319	1 ea.
550	9 278 317	9 278 333	9 278 320	1 ea.

OrgaTray 630 for Innotech Atira

Depth mm	Order no. / colour Width 270 mm			PU
	silver	white	anthracite	
470	9 288 441	9 288 443	9 288 442	1 ea.

Divider for AvanTech YOU / ArciTech

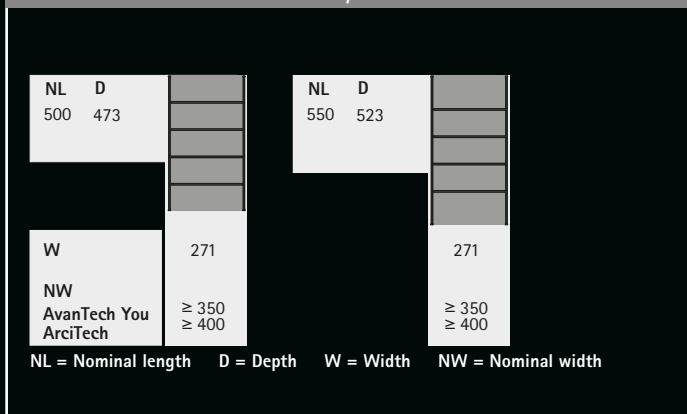

Divider for InnoTech Atira

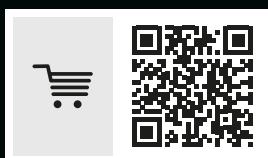
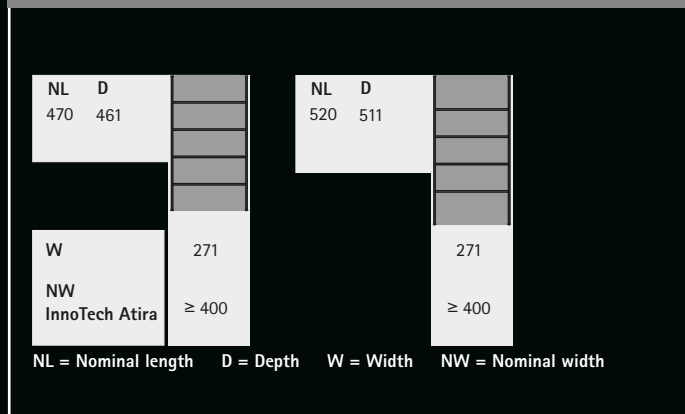

hettich.com/short/144ee6

OrgaTray 270

For AvanTech YOU / ArciTech drawer systems

Drawer Organisation:

Wood & Metal



- ▶ High quality interior organisation system made of wood
- ▶ Various cabinet body widths can be provided by combining individual articles
- ▶ Can be combined with OrgaTray 630
- ▶ It is recommended to fit an anti-slip mat
- ▶ Beech, anthracite lacquered



Anthracite



Cutlery tray

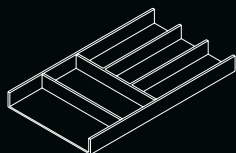

- ▶ Dimensions: W 270 x H 43 x L 423 / 473 mm

Width mm	Order no	PU
450	9 278 291	1 ea.
500	9 278 292	1 ea.

Multifunction insert

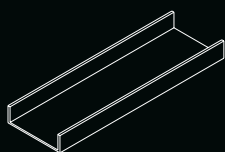

- ▶ Dimensions: W 150 x H 43 x L 423 / 473 mm

Width mm	Order no	PU
450	9 278 293	1 ea.
500	9 278 294	1 ea.

Tray

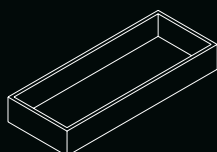

- ▶ Dimensions: W 300 x H 43 x L 105.5 / 118 mm

Depth mm	Order no	PU
105	9 278 302	1 ea.
118	9 278 301	1 ea.

OrgaTray 270

For AvanTech YOU / ArciTech drawer systems

Lengthways filler

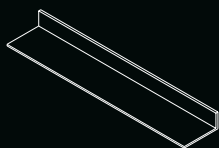

- ▶ For use in nominal lengths of 550, 600 and 650 mm
- ▶ Dimensions: W 600 / 1200 x H 43 x L 100 mm

Width mm	Order no	PU
600	9 278 313	1 ea.
1200	9 279 203	1 ea.

Connecting element

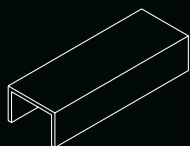

- ▶ For connecting cutlery organiser, multifunction insert and tray
- ▶ Aluminium, anodised

Set comprises:
▶ 4 connecting elements

Order no	PU
9 278 312	1 ea.

OrgaTray 270, knife holder set

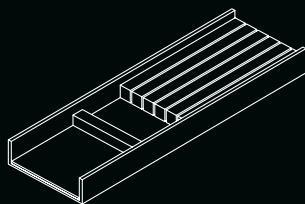

- ▶ Dimensions: W 150 mm x H 43 mm

Set comprises:
▶ Knife holder
▶ Multifunction insert

Application	Nominal length mm	Order no.	PU
AvanTech YOU, ArciTech	450	9 283 423	1 set
AvanTech YOU, ArciTech	500	9 283 426	1 set

OrgaTray 270, foil / film roll holder set

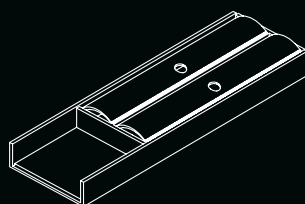

- ▶ Dimensions: W 150 mm x H 43 mm

Set comprises:
▶ Roll holder
▶ Multifunction insert

Application	Nominal length mm	Order no.	PU
AvanTech YOU, ArciTech	450	9 283 424	1 set
AvanTech YOU, ArciTech	500	9 283 413	1 set

OrgaTray 270, spice rack set

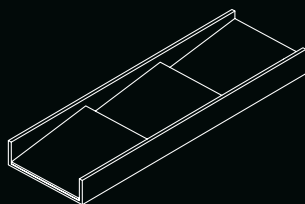

- ▶ Dimensions: W 150 mm x H 43 mm

Set comprises:
▶ Spice rack
▶ Multifunction insert

Application	Nominal length mm	Order no.	PU
AvanTech YOU, ArciTech	450	9 283 425	1 set
AvanTech YOU, ArciTech	500	9 283 414	1 set

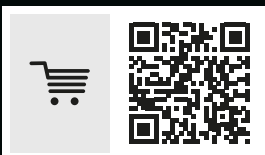

hettich.com/short/4b3ac1

OrgaTray 740

For AvanTech YOU drawer systems

Drawer Organisation:

Plastic



- ▶ Plastic cutlery insert
- ▶ Suitable for use with AvanTech YOU drawer system from drawer side profile height 101 mm
- ▶ For standard cabinet body widths
- ▶ Optimised for cabinet body side in a thickness of 16 mm
- ▶ Dimensions must be cut to size for cabinet body sides in a thickness of 16 mm
- ▶ Height 45 mm



Silver



White



Anthracite

OrgaTray 740 for AvanTech YOU

Width mm	Order no. / colour Depth 500 mm			PU
	silver	white	anthracite	
500	9 302 718	9 302 745	9 302 772	1 ea.
600	9 302 719	9 302 746	9 302 773	1 ea.
800	9 302 720	9 302 747	9 302 774	1 ea.
900	9 302 721	9 302 748	9 302 775	1 ea.
1000	9 302 722	9 302 749	9 302 776	1 ea.

Width mm	Order no. / colour Depth 550 mm			PU
	silver	white	anthracite	
500	9 302 727	9 302 754	9 302 781	1 ea.
600	9 302 728	9 302 755	9 302 782	1 ea.
800	9 302 729	9 302 756	9 302 783	1 ea.
900	9 302 730	9 302 757	9 302 784	1 ea.
1000	9 302 731	9 302 758	9 302 785	1 ea.

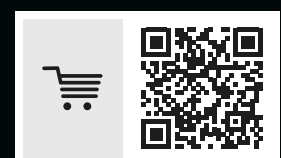

hettich.com/short/f2853f

Drawer Organisation:

Metal & Plastic



- ▶ OrgaStore 810 for ArciTech, OrgaStore 820 for InnoTech Atira, OrgaStore 830 for AvanTech YOU
- ▶ For variable or standard cabinet body width
- ▶ For use from nominal length of 300 mm
- ▶ It is recommended to use a anti-slip mat



Silver



White



Anthracite

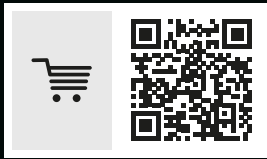

hettich.com/short/dec5ed

Profile



- ▶ Height 120 mm
- ▶ Length 2000 mm
- ▶ For cutting to length
- ▶ Powder coated aluminium

Article	Order no.			PU
	silver	white	anthracite	
AvanTech YOU (OrgaStore 830)	9 182 247	9 182 249	9 182 250	1 ea.
ArciTech (OrgaStore 810)	9 182 247	9 182 249	9 182 250	1 ea.
InnoTech Atira (OrgaStore 820)	9 194 868	9 182 249	9 182 250	1 ea.

Adapter

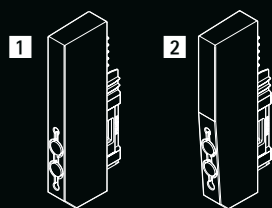

- ▶ **1** for AvanTech YOU, **2** for ArciTech / InnoTech Atira
- ▶ Height 125 mm
- ▶ Plugs onto the profile without the need for tools
- ▶ Two adapters are required for a set
- ▶ Plastic

Colour	Order no.			PU
	AvanTech YOU	ArciTech	InnoTech Atira	
silver	9 278 248		9 194 866	30 ea.
white	9 230 269	9 182 233	9 182 233	30 ea.
anthracite	9 230 268	9 182 234	9 182 234	30 ea.

Lengthwise divider

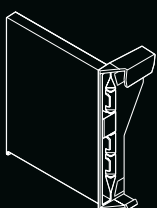

- ▶ Height 125 mm
- ▶ Plastic

Colour	Order no.			PU
	AvanTech YOU	ArciTech	InnoTech Atira	
silver	9 278 250		9 194 867	15 ea.
white	9 182 230	9 182 230	9 182 230	15 ea.
anthracite	9 230 249	9 182 231	9 182 231	15 ea.

Drawer Organisation:

Metal & Plastic

- ▶ OrgaStore 400 for ArciTech / OrgaStore 410 for InnoTech Atira
- ▶ For pot - and pan drawer or internal pot - and pan drawer with railing
- ▶ For variable or standard cabinet body width
- ▶ It is recommended to use a anti-slip mat



Silver



White



Anthracite

Railing

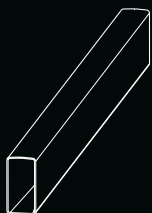

- ▶ For cutting to length
- ▶ Length 2000 mm
- ▶ Powder coated steel

Colour	Order no.		PU
	ArciTech	InnoTech Atira	
silver	9 182 706	9 194 614	30 ea.
white	9 182 714	9 194 615	30 ea.
anthracite	9 182 712	9 194 616	30 ea.

Adapter

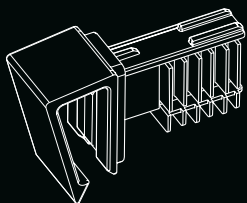

- ▶ Plastic

Colour	Order no.		PU
	ArciTech	InnoTech Atira	
silver		9 194 617	15 ea.
white	9 182 223	9 194 619	15 ea.
anthracite	9 182 222	9 194 621	15 ea.

Lengthwise divider

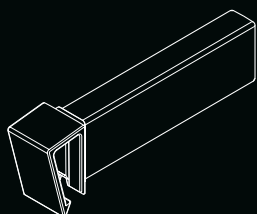

- ▶ Plastic

Colour	Order no.		PU
	ArciTech	InnoTech Atira	
silver		9 194 618	15 ea.
white	9 182 227	9 194 620	15 ea.
anthracite	9 182 225	9 194 622	15 ea.

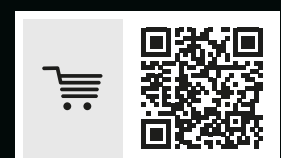

hettich.com/short/b8a05b

Drawer Organisation:

Pot & Pan – Wood



- ▶ High quality interior organisation system made of wood
- ▶ Various cabinet body widths can be provided by combining individual articles
- ▶ Can be combined with OrgaTray 270
- ▶ It is recommended to use a anti-slip mat
- ▶ Beech, anthracite lacquered



Anthracite

Box

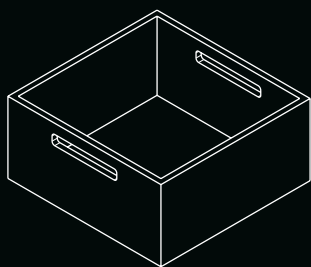

- ▶ Two boxes can be fitted one behind the other in nominal length of 500 mm
- ▶ Dimensions: W 231 x L 237 x H 110 mm

Order no	PU
9 278 309	1 ea.

Plate holder

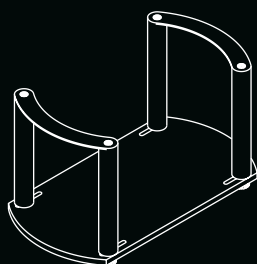

- ▶ Continuous adjustment for plate diameter from 220 mm to 280 mm
- ▶ Dimensions: W 180 x L 340 x H 191 mm

Order no	PU
9 278 310	1 ea.

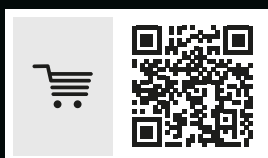

hettich.com/short/6dd7fe

Anti Slip Mats

For AvanTech YOU / ArciTech / InnoTech Atira drawer systems

Drawer Organisation:

Mats

- ▶ For inserting into the drawer
- ▶ 5 m roll
- ▶ Plastic

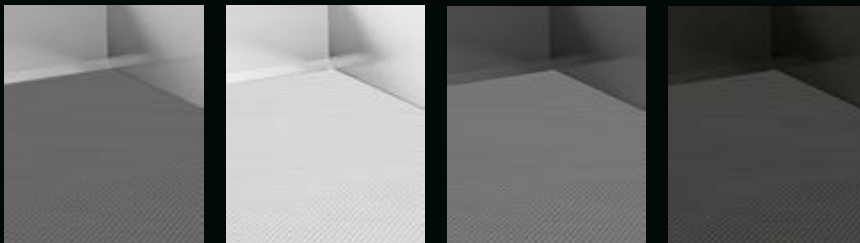

Anti-slip mat

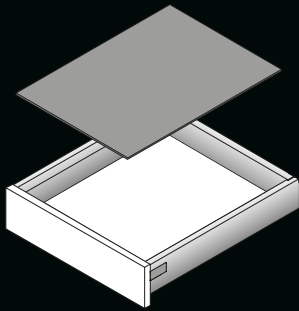

Depth mm	Order no. / colour Width 5000 mm				PU
	silver	white	anthracite	black	
470	9 209 533	9 209 572	9 209 579		1 ea.
500		9 209 573	9 209 580	9 213 636	1 ea.
520	9 209 536	9 209 574	9 209 581		1 ea.
650	9 209 568	9 209 575	9 209 582	9 213 637	1 ea.

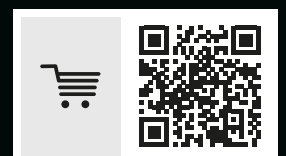

hettich.com/short/2bb1b9

Drawer Organisation:

Solutions for bottom cutout



Silver



White



Anthracite

Square



- ▶ Can be used for nominal lengths of 300 mm and over
- ▶ Use recommended on cabinet bodies in a width of 400 mm and over
- ▶ Height 53 mm plus bottom cover
- ▶ Powder coated steel

Colour	Order no.	PU
silver	9 278 342	1 ea.
white	9 278 344	1 ea.
anthracite	9 278 343	1 ea.

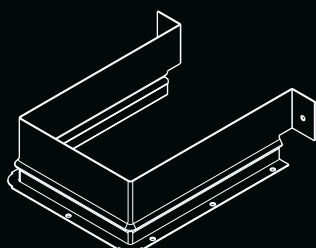

Round



- ▶ Can be used from 139 mm height for AvanTech YOU, 94 mm for ArciTech or 70 mm for InnoTech Atira
- ▶ Can be used for nominal lengths of 300 mm and over
- ▶ Use recommended on cabinet bodies in a width of 400 mm and over
- ▶ Height 67 mm plus bottom cover
- ▶ Powder coated steel

Colour	Order no.	PU
silver	9 204 282	1 ea.
white	9 204 283	1 ea.
anthracite	9 204 284	1 ea.

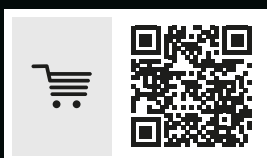
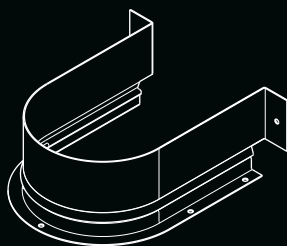

hettich.com/short/df4f8a

Banio Orga Set

For AvanTech YOU / ArciTech / InnoTech Atira drawer systems

Drawer Organisation:

Solutions for bottom cutout



- ▶ Tray system for U-bend cut-outs
- ▶ Suitable for use with AvanTech YOU from a drawer side profile height of 139 mm or with ArciTech from a drawer side profile height of 94 mm or with InnoTech Atira from a drawer side profile height of 70 mm
- ▶ Can be used for nominal lengths up to 500 mm or 470 mm with InnoTech Atira
- ▶ Recommended for use with cabinet body widths of 600 mm and over
- ▶ Height 65 mm plus bottom cover



Silver



White



Anthracite

Banio Orga Set frame

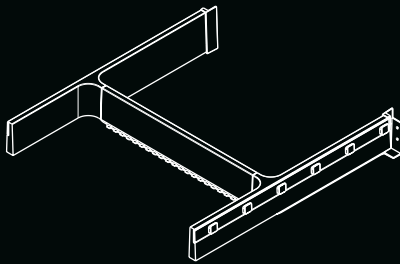

- ▶ Banio frame set
- ▶ Height 65 mm
- ▶ Frame set and tray set must be ordered separately
- ▶ Plastic

Colour	Order no.	PU
white	9 153 385	1 ea.
grey	9 153 387	1 ea.
dark grey	9 207 259	1 ea.

Banio Orga Set tray

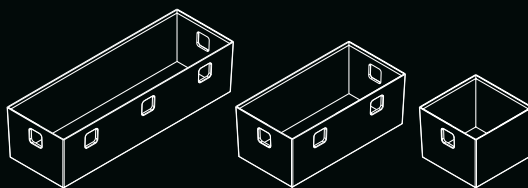

- ▶ Three part tray set for Banio system
- ▶ Height 65 mm
- ▶ Plastic
- ▶ Set consists in
 - 1 tray, 84 x 84 x 65 mm
 - 1 tray, 84 x 168 x 65 mm
 - 1 tray, 84 x 252 x 65 mm

Colour	Order no.	PU
white - translucent	9 153 388	1 ea.
graphite grey - translucent	9 207 260	1 ea.

OrgaTray 510

For AvanTech YOU / ArciTech / InnoTech Atira drawer systems

Drawer Organisation:

Solutions for bottom cutout



- ▶ Can be used from 550 mm cabinet body width and 350 mm nominal length
- ▶ Height 35 mm plus bottom cover
- ▶ Plastic



Silver



White



Anthracite

OrgaTray 510

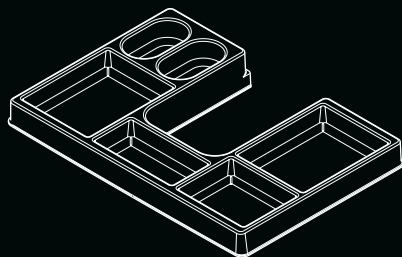

Colour	Order no.	PU
silver	9 207 045	1 ea.
white	9 207 046	1 ea.
anthracite	9 207 047	1 ea.

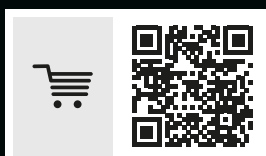

hettich.com/short/df4f8a

Drawer Organisation:

AvanTech YOU Pull Laundry 600



- ▶ Laundry basket pull-out for AvanTech YOU drawers, height 101 mm
- ▶ For nominal length (NL) of 500 mm
- ▶ For cabinet body width 600 mm
- ▶ The AvanTech YOU Pull Laundry frame is used instead of a drawer bottom panel
- ▶ Including two removable laundry baskets with handles
- ▶ Please order AvanTech YOU drawer components separately
- ▶ Frame, powder coated, silver
- ▶ Laundry baskets, white plastic

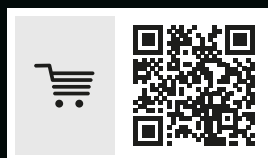

hettich.com/short/89c108

AvanTech YOU Pull Laundry 600



Set comprises:

- ▶ 1 fitted frame including front stay
- ▶ 2 laundry baskets, 
- ▶ Fixing material

Order no.	PU
9 279 106	1 set

Planning dimensions

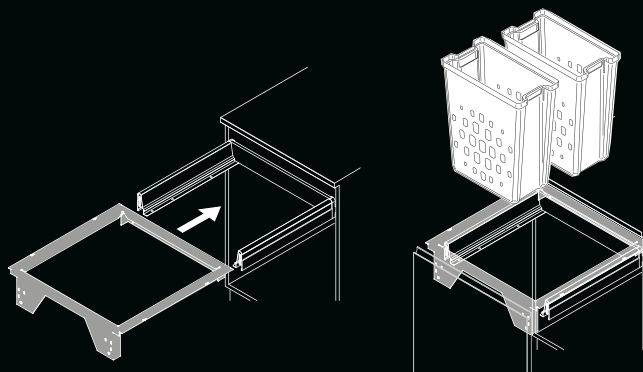
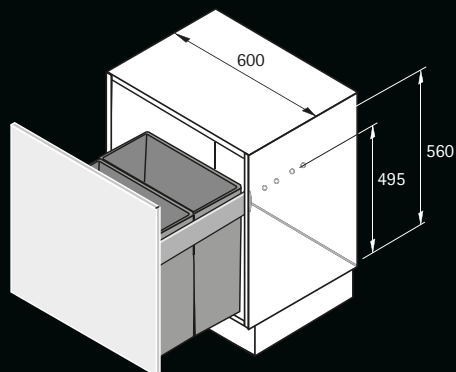

Drawer Organisation:

InnoTech Atira Pull Laundry 450 / 600



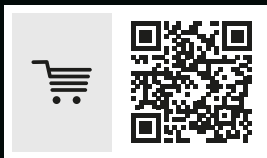

- ▶ Laundry basket pull-out for InnoTech Atira drawers, height 70 mm
- ▶ For nominal length (NL) of 470 mm
- ▶ For cabinet body width 450 / 600 mm
- ▶ The InnoTech Pull Laundry frame is used instead of a drawer bottom panel
- ▶ Including two removable laundry baskets with handles
- ▶ InnoTech Atira drawer components must be ordered separately
- ▶ Frame, powder coated, silver
- ▶ Laundry baskets, white plastic

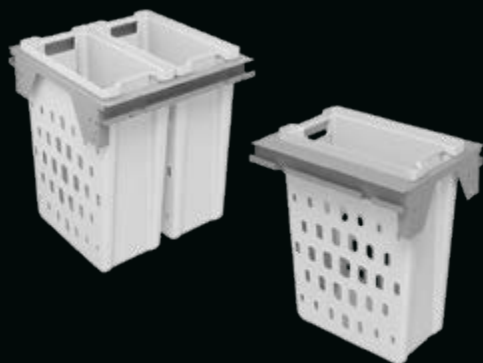

hettich.com/short/06a3ba

InnoTech Atira Pull Laundry 450 / 600



- Set comprises:
- ▶ 1 fitted frame including front stay
 - ▶ Width 450 mm: 1 laundry basket, 
 - ▶ Width 600 mm: 2 laundry baskets, 
 - ▶ Fixing material

Description	Order no.	PU
IT Pull Laundry 450	9 233 565	1 set
IT Pull Laundry 600	9 207 636	1 set

Planning dimensions

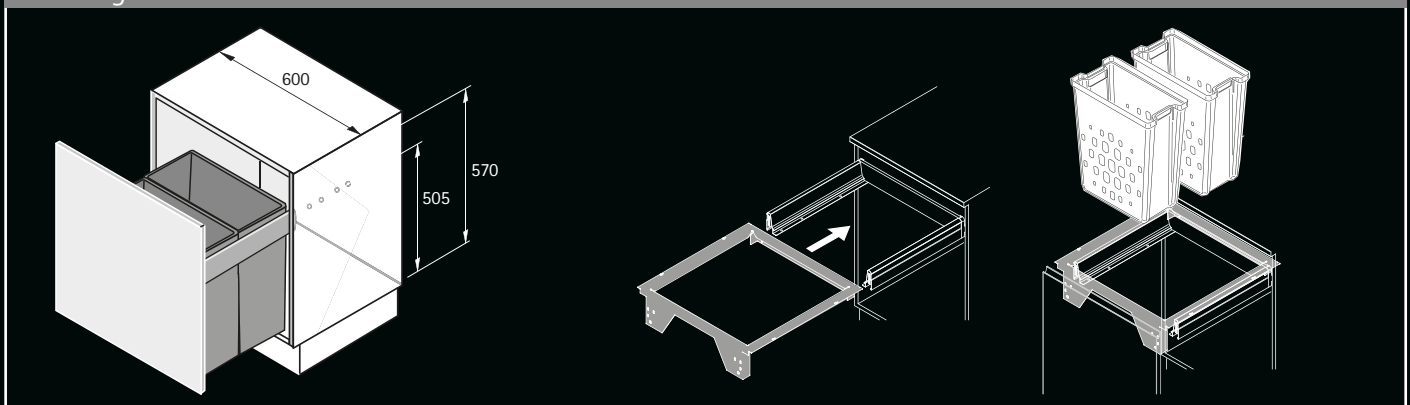

Drawer Organisation:

ArciTech Pull Laundry 450 / 600



- ▶ Laundry basket pull-out for ArciTech drawers, height 94 mm
- ▶ For nominal length (NL) of 500 mm
- ▶ For cabinet body width 450 / 600 mm
- ▶ The ArciTech Pull Laundry frame is used instead of a drawer bottom panel
- ▶ Including two removable laundry baskets with handles
- ▶ Please order ArciTech drawer components separately
- ▶ Frame, powder coated, silver
- ▶ Laundry baskets, white plastic

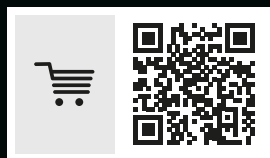



hettich.com/short/bcb9c3

ArciTech Pull Laundry 450 / 600



Set comprises:

- ▶ 1 fitted frame including front stay
- ▶ Width 450 mm: 1 laundry basket, 
- ▶ Width 600 mm: 2 laundry baskets, 
- ▶ Fixing material

Description	Order no.	PU
AT Pull Laundry 450	9 233 564	1 set
AT Pull Laundry 600	9 207 634	1 set

Planning dimensions

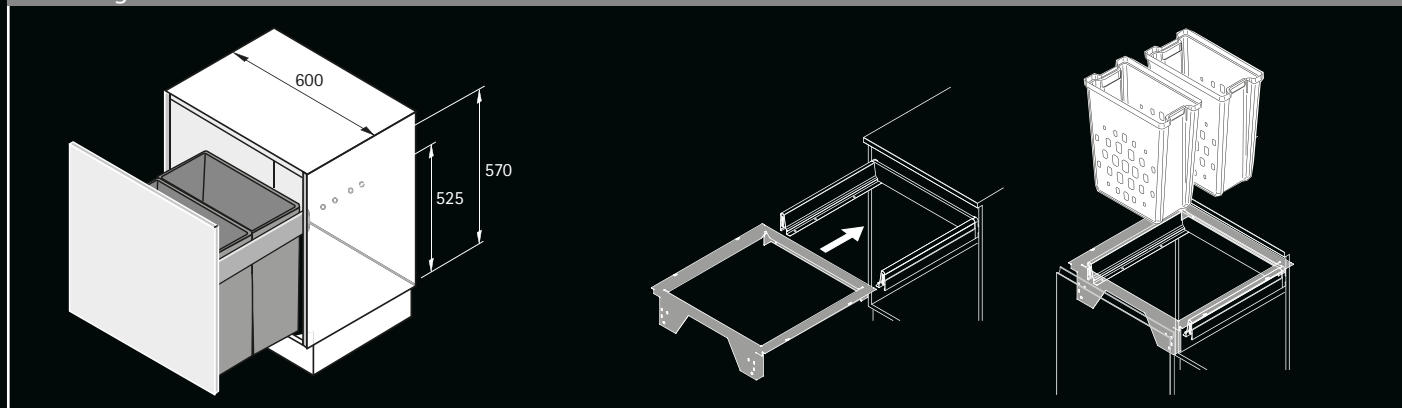

Drawer Organisation:

AvanTech YOU Pull



Anthracite

Frame

- ▶ Top running waste collecting system for AvanTech YOU drawer, 101 mm high
- ▶ The AvanTech YOU Pull frame is used instead of the drawer bottom panel
- ▶ Frame can be equipped as required with various bins and accessories
- ▶ Please order bin separately
- ▶ Please order AvanTech YOU drawer components separately
- ▶ Powder coated steel, anthracite

Set comprises:

- ▶ 1 fitted frame including front stay and lid
- ▶ Fixing material

For cabinet body width mm	Type	Order no. / Depth mm	PU
		400	
500	anthracite	9 278 339	1 set
600	anthracite	9 278 340	1 set

For cabinet body width mm	Type	Order no. / Depth mm	PU
		500	
450	anthracite	9 278 334	1 set
500	anthracite	9 278 335	1 set
600	anthracite	9 278 336	1 set
600	anthracite / 600 - 2 (for 2 x 40 l)	9 278 337	1 set

Planning dimensions

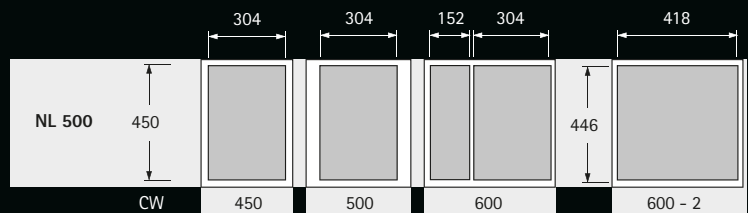
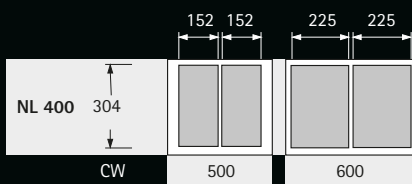

NL = Nominal length CW = Cabinet body width

NL = Nominal length CW = Cabinet body width

Waste Collecting Systems

For ArciTech drawer systems

Drawer Organisation:

ArciTech Pull



Anthracite

Frame

- ▶ Top running waste collecting system for ArciTech drawer, 94 mm high
- ▶ The ArciTech Pull frame is used instead of the drawer bottom panel
- ▶ Frame can be equipped as required with various bins and accessories
- ▶ Please order bin separately
- ▶ Please order ArciTech drawer components separately
- ▶ Powder coated steel, anthracite

Set comprises:

- ▶ 1 fitted frame including front stay and lid
- ▶ Fixing material

For cabinet body width mm	Type	Order no. / Depth mm	PU
		500	
300	anthracite	9 279 400	1 set
400	anthracite	9 279 401	1 set
450	anthracite	9 279 402	1 set
500	anthracite	9 279 403	1 set
600	anthracite	9 279 404	1 set
600	anthracite / 600 - 2 (for 2 x 40 l)	9 279 405	1 set

For cabinet body width mm	Type	Capacity	Order no. / Depth mm	PU
			500	
450	AT Pull 34 l / anthracite	2 x 17 l	9 304 690	1 set
450	AT Pull 58 l / anthracite	2 x 29 l	9 304 691	1 set
500	AT Pull 58 l / anthracite	2 x 29 l	9 304 692	1 set
600	AT Pull 80 l / anthracite	2 x 40 l	9 304 693	1 set

Planning dimensions

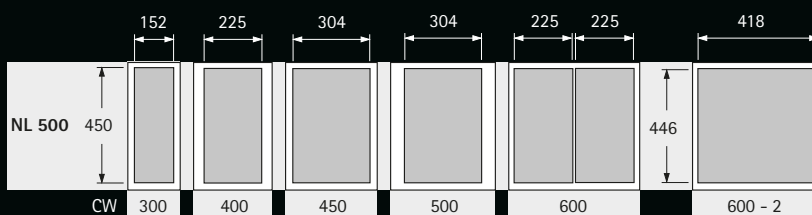

NL = Nominal length CW = Cabinet body width

Drawer Organisation:

InnoTech Atira Pull



Anthracite

Frame

- ▶ Top running waste collecting system for InnoTech Atira drawer, 70 mm high
 - ▶ The InnoTech Pull frame is used instead of the drawer bottom panel
 - ▶ Frame can be equipped as required with various bins and accessories
 - ▶ Please order bin separately
 - ▶ Please order InnoTech Atira drawer components separately
 - ▶ Powder coated steel, anthracite
- Set comprises:
- ▶ 1 fitted frame including front stay and lid
 - ▶ Fixing material

For cabinet body width mm	Type	Order no. / Depth mm	PU
		470	
300	anthracite	9 279 409	1 set
400	anthracite	9 279 410	1 set
450	anthracite	9 279 411	1 set
500	anthracite	9 279 412	1 set
600	anthracite	9 279 413	1 set
600	anthracite / 600 - 2 (for 2 x 40 l)	9 279 414	1 set

For cabinet body width mm	Type	Capacity	Order no. / Depth mm	PU
			470	
400	IT Pull 37 l / anthracite	1 x 29 l / 1 x 8 l	9 304 683	1 set
450	IT Pull 34 l / anthracite	2 x 17 l	9 304 684	1 set
450	IT Pull 58 l / anthracite	2 x 29 l	9 304 685	1 set
500	IT Pull 34 l / anthracite	2 x 17 l	9 304 686	1 set
500	IT Pull 58 l / anthracite	2 x 29 l	9 304 687	1 set
600	IT Pull 74 l / anthracite	2 x 29 l / 2 x 8 l	9 304 688	1 set
600	IT Pull 80 l / anthracite	2 x 40 l	9 304 689	1 set

Planning dimensions

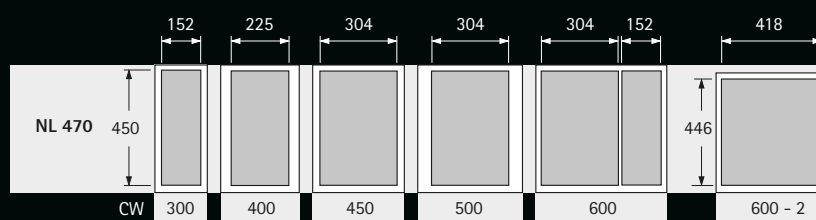

NL = Nominal length CW = Cabinet body width

Drawer Organisation:



for AvanTech YOU Pull, ArciTech Pull and InnoTech Atira Pull

- ▶ For fitting any chosen component in the AvanTech YOU Pull, ArciTech Pull or InnoTech Atira Pull frame
- ▶ Plastic bin with sturdy double handle
- ▶ As standard, all bins are supplied without lid
- ▶ Lids must be ordered separately, see below
- ▶ The lid heights specified below are total dimensions, the additional height for all lids is 2 mm

Bin

Article	Material / finish	Width mm	Depth mm	Height mm	Order no.	PU
Bin 8 l	Plastic anthracite	152	225	295	9 279 390	1 ea.
Bin 11 l	Plastic anthracite	152	304	295	9 279 391	1 ea.
Bin 17 l	Plastic anthracite	225	304	295	9 279 392	1 ea.
Bin 29 l	Plastic anthracite	225	304	460	9 279 393	1 ea.
Bin 40 l	Plastic anthracite	223	418	505	9 279 394	1 ea.

Lid

Article	Material / finish	Width mm	Depth mm	Height mm	Order no.	PU
Lid 8 l	Plastic anthracite	152	225	21	9 279 396	1 ea.
Lid 11 l	Plastic anthracite	152	304	21	9 279 397	1 ea.
Lid 17 / 29 l	Plastic anthracite	225	304	21	9 279 398	1 ea.
Lid 40	Plastic anthracite	223	418	21	9 279 399	1 ea.

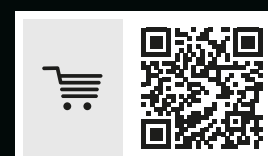

Drawer Organisation:

for AvanTech YOU, ArciTech and InnoTech Atira

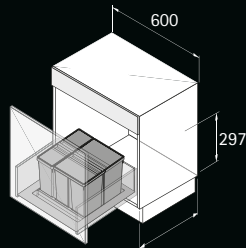
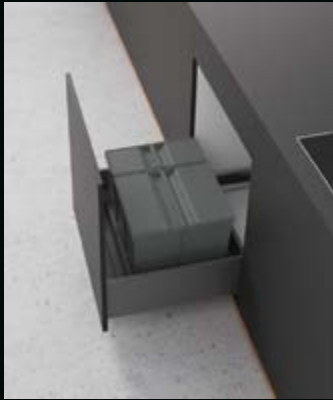

Bin.it Prime 600



AvanTech YOU / ArciTech =
NL 450 / 500
InnoTech Atira =
NL 420 / 470

- ▶ For use in pot-and-pan drawer, e.g. for AvanTech YOU and ArciTech, nominal length (NL) 450 mm / 500 mm or for InnoTech Atira, nominal length (NL) 420 mm / 470 mm
- ▶ For cabinet width 600 mm
- ▶ Capacity 37 litres
- ▶ Installed height 297 mm as from upper edge of drawer bottom panel
- ▶ Fitted tray can be cut to size, dimensions for cutting to size:
max. width 540 mm, max. depth 490 mm
min. width 430 mm, min. depth 399 mm
- ▶ Fitted tray, bin and lid, anthracite plastic

Set comprises:

- ▶ 2 bins with lid  + 
- ▶ 1 fitted tray

Order no.	PU
9 220 394	1 set

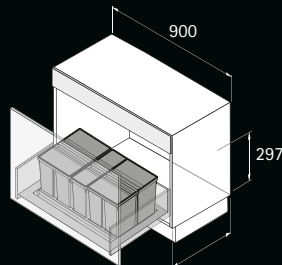

Bin.it Prime 900



AvanTech YOU / ArciTech =
NL 450 / 500
InnoTech Atira =
NL 420 / 470

- ▶ For use in pot-and-pan drawer, e.g. for AvanTech YOU and ArciTech, nominal length (NL) 450 mm / 500 mm or for InnoTech Atira, nominal length (NL) 420 mm / 470 mm
- ▶ For cabinet width 900 mm
- ▶ Capacity 63 litres
- ▶ Installed height 297 mm as from upper edge of drawer bottom panel
- ▶ Fitted tray can be cut to size, dimensions for cutting to size:
max. width 840 mm, max. depth 490 mm
min. width 730 mm, min. depth 399 mm
- ▶ Fitted tray, bin and lid, anthracite plastic

Set comprises:

- ▶ 3 bins with lid  +  + 
- ▶ 1 fitted tray

Order no.	PU
9 220 395	1 set

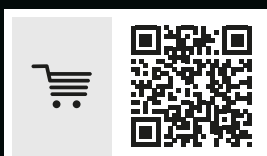

hettich.com/short/ba0dcb

Order number index

Order no.	Page
0 044 934	4
0 074 430	4
9 079 207	4
9 134 977	5
9 134 979	5
9 134 980	5
9 134 991	5
9 134 992	5
9 134 993	5
9 134 994	5
9 134 995	5
9 135 015	5
9 135 016	5
9 135 017	5
9 135 018	5
9 135 019	5
9 135 020	5
9 135 031	5
9 135 032	5
9 153 385	15
9 153 387	15
9 153 388	15
9 182 222	11
9 182 223	11
9 182 225	11
9 182 227	11
9 182 230	10
9 182 230	10
9 182 230	10
9 182 231	10
9 182 231	10
9 182 233	10
9 182 233	10
9 182 234	10
9 182 234	10
9 182 247	10
9 182 247	10
9 182 249	10
9 182 249	10
9 182 249	10
9 182 249	10
9 182 250	10
9 182 250	10
9 182 250	10
9 182 706	11
9 182 712	11
9 182 714	11
9 183 328	5
9 183 329	5
9 183 330	5
9 183 331	5
9 183 332	5
9 183 333	5
9 183 334	5
9 183 335	5
9 194 614	11
9 194 615	11

Order no.	Page
9 194 616	11
9 194 617	11
9 194 618	11
9 194 619	11
9 194 620	11
9 194 621	11
9 194 622	11
9 194 866	10
9 194 867	10
9 194 868	10
9 194 886	3
9 194 887	3
9 194 888	3
9 194 889	3
9 194 891	3
9 194 892	3
9 194 893	3
9 194 894	3
9 194 897	3
9 194 898	3
9 194 899	3
9 194 900	3
9 194 902	3
9 194 903	3
9 194 904	3
9 194 905	3
9 194 908	3
9 194 909	3
9 194 910	3
9 194 911	3
9 194 913	3
9 194 914	3
9 194 915	3
9 194 916	3
9 194 918	4
9 194 919	4
9 194 920	4
9 194 921	4
9 194 922	4
9 194 923	4
9 194 924	4
9 194 925	4
9 194 926	4
9 194 927	4
9 194 928	4
9 194 929	4
9 194 931	4
9 194 932	4
9 194 933	4
9 194 934	4
9 194 935	4
9 194 936	4
9 194 937	4
9 194 938	4
9 194 939	4
9 194 940	4

Order no.	Page
9 194 941	4
9 194 942	4
9 194 949	4
9 194 950	4
9 194 951	4
9 194 952	4
9 194 953	4
9 194 954	4
9 194 955	4
9 194 956	4
9 194 957	4
9 194 958	4
9 194 959	4
9 194 960	4
9 194 962	4
9 194 963	4
9 194 964	4
9 194 965	4
9 194 966	4
9 194 967	4
9 194 968	4
9 194 969	4
9 194 970	4
9 194 971	4
9 194 972	4
9 194 973	4
9 194 980	4
9 194 981	4
9 194 982	4
9 194 983	4
9 194 984	4
9 194 985	4
9 194 986	4
9 194 987	4
9 194 988	4
9 194 989	4
9 194 990	4
9 194 991	4
9 194 993	4
9 194 994	4
9 194 995	4
9 194 996	4
9 194 997	4
9 194 998	4
9 194 999	4
9 195 000	4
9 195 001	4
9 195 002	4
9 195 003	4
9 195 004	4
9 204 200	5
9 204 203	5
9 204 282	14
9 204 283	14
9 204 284	14
9 207 045	16

Order number index

Order no.	Page	Order no.	Page	Order no.	Page
9 207 046	16	9 278 331	6	9 302 747	9
9 207 047	16	9 278 332	6	9 302 748	9
9 207 220	2	9 278 333	6	9 302 749	9
9 207 222	2	9 278 334	20	9 302 754	9
9 207 224	2	9 278 335	20	9 302 755	9
9 207 226	2	9 278 336	20	9 302 756	9
9 207 227	2	9 278 337	20	9 302 757	9
9 207 238	2	9 278 339	20	9 302 758	9
9 207 241	2	9 278 340	20	9 302 772	9
9 207 242	2	9 278 342	14	9 302 773	9
9 207 243	2	9 278 343	14	9 302 774	9
9 207 245	2	9 278 344	14	9 302 775	9
9 207 246	2	9 279 106	17	9 302 776	9
9 207 247	2	9 279 203	8	9 302 781	9
9 207 259	15	9 279 390	23	9 302 782	9
9 207 260	15	9 279 391	23	9 302 783	9
9 207 634	19	9 279 392	23	9 302 784	9
9 207 636	18	9 279 393	23	9 302 785	9
9 209 533	13	9 279 394	23	9 304 683	22
9 209 536	13	9 279 396	23	9 304 684	22
9 209 568	13	9 279 397	23	9 304 685	22
9 209 572	13	9 279 398	23	9 304 686	22
9 209 573	13	9 279 399	23	9 304 687	22
9 209 574	13	9 279 400	21	9 304 688	22
9 209 575	13	9 279 401	21	9 304 689	22
9 209 579	13	9 279 402	21	9 304 690	21
9 209 580	13	9 279 403	21	9 304 691	21
9 209 581	13	9 279 404	21	9 304 692	21
9 209 582	13	9 279 405	21	9 304 693	21
9 213 636	13	9 279 409	22		
9 213 637	13	9 279 410	22		
9 220 394	24	9 279 411	22		
9 220 395	24	9 279 412	22		
9 230 249	10	9 279 413	22		
9 230 268	10	9 279 414	22		
9 230 269	10	9 283 413	8		
9 233 564	19	9 283 414	8		
9 233 565	18	9 283 423	8		
9 278 248	10	9 283 424	8		
9 278 250	10	9 283 425	8		
9 278 291	7	9 283 426	8		
9 278 292	7	9 288 441	6		
9 278 293	7	9 288 442	6		
9 278 294	7	9 288 443	6		
9 278 301	7	9 302 718	9		
9 278 302	7	9 302 719	9		
9 278 309	12	9 302 720	9		
9 278 310	12	9 302 721	9		
9 278 312	8	9 302 722	9		
9 278 313	8	9 302 727	9		
9 278 315	6	9 302 728	9		
9 278 316	6	9 302 729	9		
9 278 317	6	9 302 730	9		
9 278 318	6	9 302 731	9		
9 278 319	6	9 302 745	9		
9 278 320	6	9 302 746	9		

Technical information / legal notice

General technical conditions

The fitting information, screw fixing points and load capacity information contained in this catalogue assume proper attachment using screws specified by Hettich to a chipboard panel providing a screw pull out resistance of at least 1,000 N in accordance with EN 320.

Hettich accepts no responsibility for the load capacity of furniture and its components if materials or fastening methods are used other than those stated; the furniture manufacturer must verify load capacity.

The fitting situations shown in this catalogue are only intended to illustrate the possible options.

The furniture manufacturer is responsible for ensuring that furniture is designed in compliance with standards, in particular with regard to meeting the requirements on safety.

We will be pleased to provide any further information you may require.

General Terms of Sale and Delivery

All products and services will be provided exclusively on the basis of our General Terms of Sale and Delivery published on our website at www.hettich-agb.com.

Legal notice

© Hettich Marketing- und Vertriebs GmbH & Co. KG
Gerhard - Lüking - Str. 10
32602 Vlotho · Germany

November 2021

We reserve all rights to this catalogue under copyright law. It shall not be permissible to duplicate this catalogue in any form either in whole or in part without our written consent. Subject to technical alterations. Errors and omissions excepted. Subject to colour variations.

Order no. 9 311 160

Let's move markets!



Order no.: 9 311 160
2110-039_ Internal_Organisation_11/21_HAU/en

Technik für Möbel

Hettich