



German quality you can trust



Aluminium Profile Collection  
**Frame • Edge • Handle**  
effective June, 2023







Hettich offers a range of Aluminium Profiles which cater to the contemporary trends of aesthetics in home interiors. Hettich's range of Aluminium Profiles enhances the appearance of your kitchen cabinet doors with a sleek elegant look. These Profiles are easy to assemble and can be installed with the help of compatible accessories available with Hettich.

Aluminium Profiles are mainly used with Glass Panels of varying thicknesses and provide a seamless everlasting sleek solution for your kitchen and wardrobe shutters.



Overhead Storages



Bottom Cabinets



Sliding Doors



Handles



19 mm Straight Frame Profile

4



45 mm Straight Frame Profile

5



45 mm Straight Profile - 6mm Glass

5



45 mm Straight Stick On Profile

5-6



55 mm Straight Profile

6



Edge Profiles

7



Mid Way Profile

7



Gola Profile

8



Gola Profile for vertical use

9



Sink Counter Profile with Connectors

10



Profile Handles

11-12

Aluminium Profile Finishes

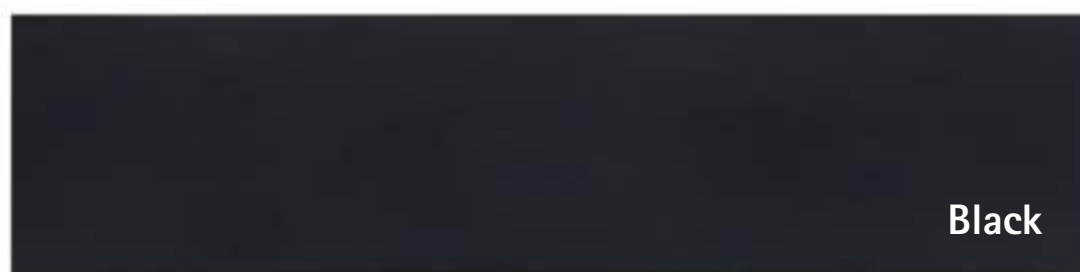
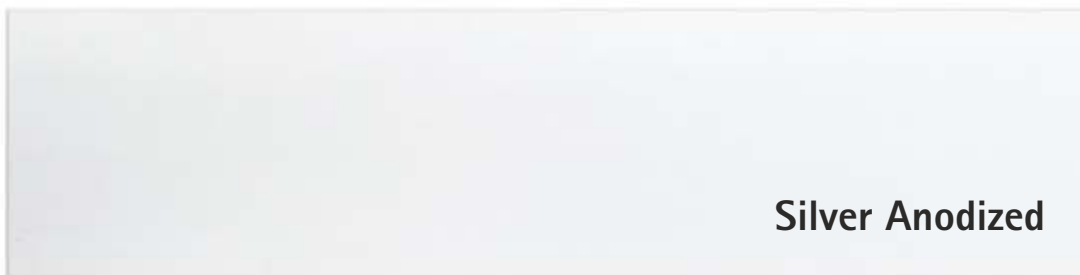

# Aluminium Profile Collection

- ▶ 19 mm Straight Frame with Compatible Handle Profile
- ▶ 4 mm Glass Panel Shutters



## 19 mm Straight Frame Profile & Handle



- ▶ Profile for 4 mm Thick Glass Panels
- ▶ Available in multiple finishes
- ▶ Angle connectors to be procured separately (Refer Page no. 14)
- ▶ Glass Size (HxW) = Frame height less 26 mm x Frame width less 26 mm

Description	Profile Section	Glass Thickness	Width (mm)	Length (mm)	Finish	Article No.	PU	MRP
19 mm Straight Frame Profile		4 mm	19	3000	SA	9 288 843	4	1,386
					SS	9 307 821	4	2,110
					BL	9 307 822	4	2,110
					CP	9 307 823*	4	2,110
					DC	9 310 257	4	2,110
19 mm Straight Frame Profile with handle		4 mm	19	3000	SA	9 283 472	4	1,764
					SS	9 307 824	4	2,690
					BL	9 307 825	4	2,690
					CP	9 307 826*	4	2,690
					DC	9 310 258	4	2,690



\*Available till stock last

- SA - Silver finish
- SS - Stainless steel finish
- BL - Black finish
- CP - Chrome finish
- DC - Dark Champagne finish



# Aluminium Profile Collection

- ▶ 45 mm Straight Frame with Compatible Handle Profile
- ▶ 4 mm & 6 mm Glass Panel Shutters



## 45 mm Straight Profile & Handles



- ▶ Profile for 4 mm Thick Glass Panels
- ▶ Available in multiple finishes
- ▶ Angle connectors to be procured separately (Refer Page no. 14)
- ▶ Glass Size (HxW) = Frame height less 7 mm x Frame width less 7 mm

Note: Handle width should not be considered in Frame size

Description	Profile Section	Glass Thickness	Width (mm)	Length (mm)	Finish	Article No.	PU	MRP
45 mm Straight Frame Profile		4 mm	45	3000	SA	9 283 473	4	2,783
					SS	9 307 827	4	4,240
					BL	9 307 828	4	4,240
					CP	9 307 829*	4	4,240
					DC	9 310 254	4	4,240
45 mm Straight Frame Profile with L Handle		4 mm	45	3000	SA	9 283 485	4	3,633
					SS	9 307 830	4	5,530
					BL	9 307 847	4	5,530
					CP	9 307 848*	4	5,530
					DC	9 310 256	4	4,860
45mm Straight Frame Profile with C Handle		4 mm	45	3000	SA	9 283 474	4	3,455
45 mm Straight Frame Profile with F Handle		4 mm	45	3000	SA	9 283 494	4	3,350
					SS	9 307 849	4	4,880
					BL	9 307 851	4	4,880
					CP	9 307 852*	4	4,880
					DC	9 322 379	4	4,880
45mm Straight Frame Profile for 6 mm glass		6 mm	45	3000	SA	9 283 490	4	2,321
45 mm Straight Frame Profile with L Handle for 6 mm glass		6 mm	45	3000	SA	9 283 493	4	3,119
45 mm Straight frame Stick on Profile		4 mm	45	3000	SA	9 283 488	4	2,247
					SS	9 302 252	4	3,420
					BL	9 302 253	4	3,420
					CP	9 302 254*	4	3,420
45 mm Straight Frame Stick On Profile with L Handle		4 mm	45	3000	SA	9 283 487	4	3,045
					SS	9 302 229	4	4,630
					BL	9 302 230	4	4,630
					CP	9 302 251*	4	4,630
45 mm Straight Frameless Stick on Profile		4 mm	45	3000	SA	9 306 110	4	2,279
					SS	9 306 161	4	3,460
					BL	9 306 163	4	3,460
					CP	9 306 162*	4	3,460

\*Available till stock last

- SA - Silver finish
- SS - Stainless steel finish
- BL - Black finish
- CP - Chrome finish
- DC - Dark Champagne finish

# Aluminium Profile Collection

- ▶ 45/55 mm Straight Frame with Compatible Handle Profile
- ▶ 4/5/8 mm Glass Panel Shutters



Description	Profile Section	Glass Thickness	Width (mm)	Length (mm)	Finish	Article No.	PU	MRP
45 mm Straight Frameless Stick on Handle Profile		4 mm	45	3000	SA	9 306 164	4	2,909
					SS	9 306 165	4	4,420
					BL	9 306 167	4	4,420
					CP	9 306 166*	4	4,420

## 55 mm Straight Profile & Handle



- ▶ Profile for 4 mm Thick Glass Panels
- ▶ Available in multiple finishes
- ▶ Angle connectors to be procured separately (Refer Page no. 14)
- ▶ Glass Size (HxW) = Frame height less 7 mm x Frame width less 7 mm

Note: Handle width should not be considered in Frame size

Description	Profile Section	Glass Thickness	Width (mm)	Length (mm)	Finish	Article No.	PU	MRP
55 mm Straight Frame Profile		4 mm	55	3000	SA	9 288 842	4	2,783
					SS	9 307 853	4	4,240
					BL	9 307 854	4	4,240
					CP	9 307 855*	4	4,240
					DC	9 310 252	4	4,240
55 mm Straight Frame Profile with C Handle		4 mm	55	3000	SA	9 288 844	4	3,434
					SS	9 307 856	4	5,230
					BL	9 307 857	4	5,230
					CP	9 307 858*	4	5,230
					DC	9 310 253	4	5,230
55 mm Curved Frame Profile		4/5 mm	55	3000	SA	9 288 848	4	3,402
Alu Profile 55 mm curved with C Handle		4/5 mm	55	3000	SA	9 283 471	4	4,845
55 mm Straight Frame Profile		8 mm	55	3000	SA	9 283 491	4	2,636
					SS	9 340 558	4	3,430
					BL	9 340 557	4	3,430
					DC	9 340 559	4	3,430
55 mm Straight Frame Profile with F Handle		8 mm	55	3000	SA	9 283 495	4	3,255
					SS	9 340 571	4	4,230
					BL	9 340 560	4	4,230
					DC	9 340 572	4	4,230

\*Available till stock last

- SA - Silver finish
- SS - Stainless steel finish
- BL - Black finish
- CP - Chrome finish
- DC - Dark Champagne finish



# Aluminium Profile Collection

- ▶ Special Profiles
- ▶ Edge Profiles Et Mid Way Joining Profiles



## Mid Way Joining Profile



- ▶ Mid way joining Profile for 4 mm / 5 mm Thick Glass Panels
- ▶ Available in multiple finishes



Description	Profile Section	Glass Thickness	Width (mm)	Length (mm)	Finish	Article No.	PU	MRP
Mid Way Joining Profile		4 / 5 mm	16	3000	SA	9 283 496	8	1,313
					SS	9 307 861	8	1,880
					BL	9 307 862	8	1,880
					CP	9 307 863*	8	1,880
					DC	9 310 261	8	1,735

## Edge Profiles



- ▶ Edge Profile for 19 mm / 22 mm Thick Wooden Panels
- ▶ Available in multiple finishes
- ▶ Used to provide an aesthetic appeal and protect the edges of panels

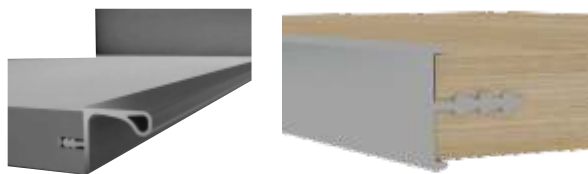

Description	Profile Section	Edge Thickness	Width (mm)	Length (mm)	Finish	Article No.	PU	MRP
Edge Profile (22 mm)		19 mm board thickness	-	3000	SA	9 283 498	8	546
					SS	9 299 208	8	830
					BL	9 307 613	8	830
					CP	9 302 261*	8	830
					DC	9 310 262	8	830
Edge Profile (25 mm)		22 mm board thickness	-	3000	SA	9 283 500	8	609
					SS	9 299 209	8	930
					BL	9 307 614	8	930
					CP	9 302 262*	8	930
					DC	9 310 263	8	930
Edge Profile for Wall Cabinet		16.8 mm board thickness onwards	-	3000	SA	9 283 517	12	1,754
					SS	9 299 223	12	2,670
					BL	9 307 859	12	2,670
					CP	9 307 860*	12	2,670
					DC	9 310 267	12	2,670
Edge Profile for Wall Cabinet		18.8 mm board thickness onwards	-	3000	SA	9 312 136	12	1,827
					SS	9 312 247	12	2,790
					BL	9 312 249	12	2,790
					CP	9 312 248*	12	2,790
					DC	9 322 380	12	2,790

\*Available till stock last

- SA - Silver finish
- SS - Stainless steel finish
- BL - Black finish
- CP - Chrome finish
- DC - Dark Champagne finish

# Aluminium Profile Collection

- ▶ Special Profiles
- ▶ Gola Profiles for Cabinets



## Gola Profiles



- ▶ Gola Profile for 19 mm / 22 mm Thick Wooden Panels
- ▶ Available in multiple finishes
- ▶ Used to provide an aesthetic appeal and protect the edges of panels



Description	Profile Section	Length (mm)	Finish	Article No.	PU	MRP
Gola Profile C Type		3000	SA	9 283 515	10	2,027
			SS	9 299 221	10	3,090
			BL	9 299 226	10	3,090
			CP	9 300 522*	10	3,090
			DC	9 310 426	10	3,090
Gola Profile L Type		3000	SA	9 283 516	10	1,596
			SS	9 299 222	10	2,400
			BL	9 299 225	10	2,400
			CP	9 300 521*	10	2,400
			DC	9 310 427	10	2,400



\*Available till stock last

- SA - Silver finish
- SS - Stainless steel finish
- BL - Black finish
- CP - Chrome finish
- DC - Dark Champagne finish

# Aluminium Profile Collection

- ▶ Special Profiles
- ▶ Gola Profile for vertical use



## Gola Profile for vertical use



Description	Profile Section	Length ( mm)	Finish	Article No.	PU	MRP
Gola Profile (Vertical application)	<p>Double side C Profile</p>	3000	SA	9 293 474	4	2,919
			SS	9 302 257	4	4,440
			BL	9 300 496	4	4,440
			CP	9 300 524*	4	4,440
			DC	9 310 269	4	4,440
Gola Profile (Vertical application)	<p>Single side L Profile</p>	3000	SA	9 293 473	4	2,594
			SS	9 302 256	4	3,940
			BL	9 300 494	4	3,940
			CP	9 300 523*	4	3,940
			DC	9 310 268	4	3,940

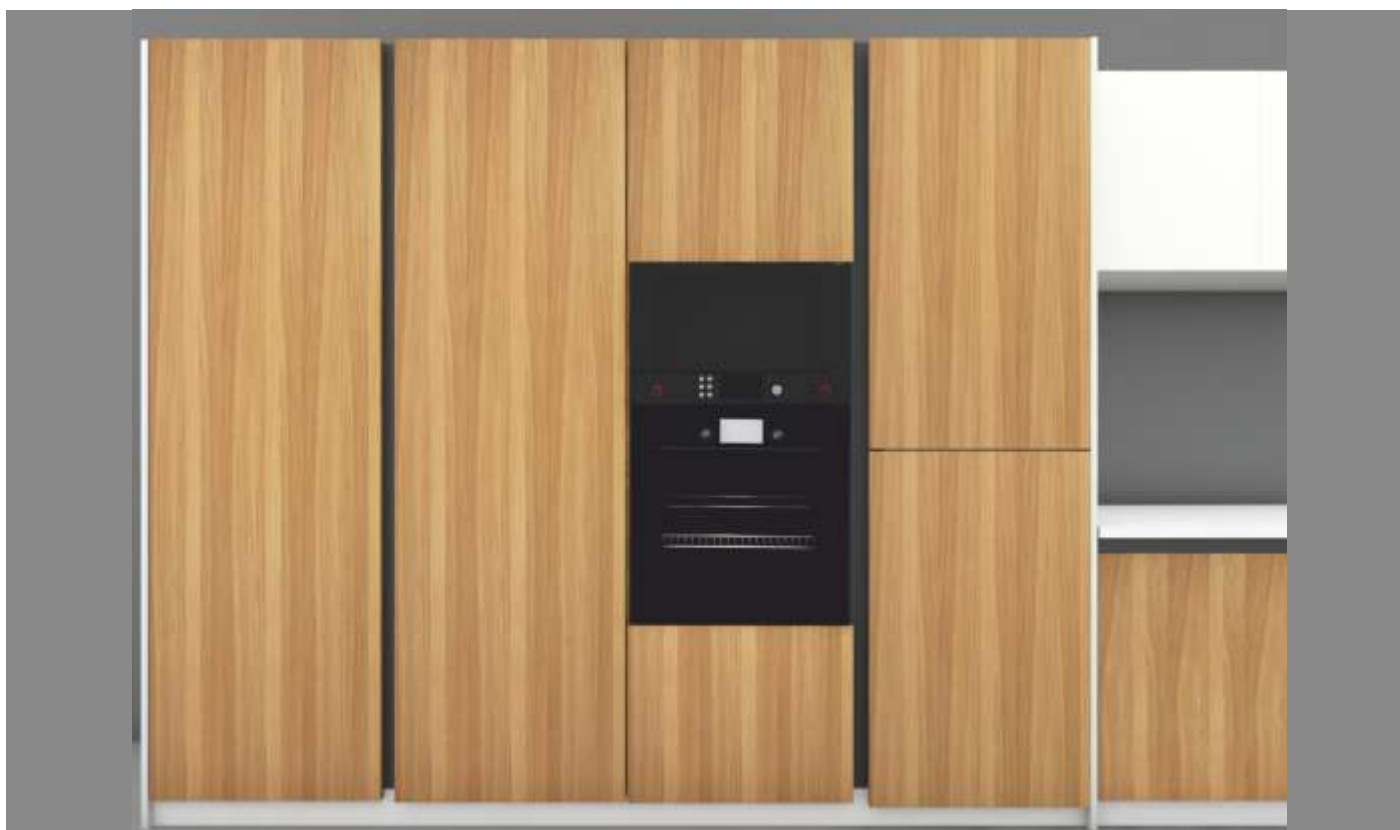

\*Available till stock last

- SA - Silver finish
- SS - Stainless steel finish
- BL - Black finish
- CP - Chrome finish
- DC - Dark Champagne finish

# Aluminium Profile Collection

- ▶ Special Profiles
- ▶ Sink Counter Profile



## Sink Counter Profile



Description	Profile Section	Length (mm)	Finish	Article No.	PU	MRP
Sink Counter Profile		3000	SA	9 293 475	6	1,806



- SA - Silver finish
- SS - Stainless steel finish
- BL - Black finish
- CP - Chrome finish
- DC - Dark Champagne finish

### Handle Eslinga (G Profile) with End cap

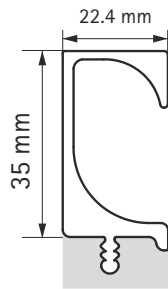

Details	Length (mm)	Finish	Article No.	PU	MRP
Profile 35 mm (H) Et (L) 3000 mm	3000	SA	9 316 534	4	2,835
		BL	9 306 108	4	4,340
End cap		SA	9 316 535	1	10
		BL	9 306 109	1	10

### Eslinga G Profile

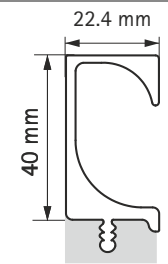

Details	Length (mm)	Finish	Article No.	PU	MRP
Profile height 40mm	3000	SA	9 283 502	4	3,728
		SS	9 322 411	4	4,980
		BL	9 302 228	4	4,980
		DC	9 322 412	4	4,980

### Eslinga Econ - G Profile

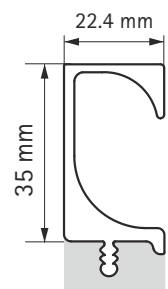

Details	Length (mm)	Finish	Article No.	PU	MRP
Profile height 35mm	3000	SA	9 283 503	4	2,877
		SS	9 299 210	4	4,390
		BL	9 299 224	4	4,390
		DC	9 310 266	4	4,390

### Lutetia

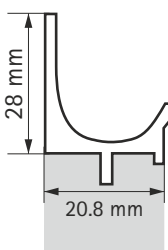

Details	Length (mm)	Finish	Article No.	PU	MRP
Profile Ht- 28 mm	3000	SA	9 133 756	4	2,342
		SS	9 322 413	4	3,130
		BL	9 322 414	4	3,130
		DC	9 310 302	4	3,130

### Seveso - 19mm Panels

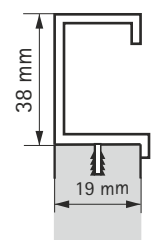

Details	Length (mm)	Finish	Article No.	PU	MRP
Profile height 38 mm for 19 mm thickness	2400	SA	1 161 200	6	1,491
		SS	9 333 370	6	1,890
		BL	9 333 371	6	1,890
		DC	9 333 372	6	1,890

\*Available till stock last

• SA - Silver finish • SS - Stainless steel finish • BL - Black finish • CP - Chrome finish • DC - Dark Champagne finish

## Seveso - 17mm Panels

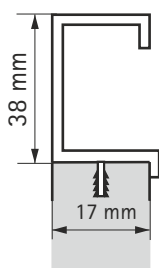

Details	Length (mm)	Finish	Article No.	PU	MRP
Profile height 38 mm for 17 mm thickness	2400	SA	1 161 199	6	1,419
		SS	9 338 908	6	1,815
		BL	9 338 906	6	1,815
		DC	9 338 907	6	1,815

## Calisia

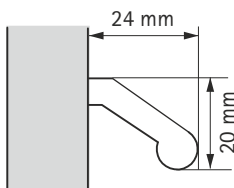

Details	Length (mm)	Finish	Article No.	PU	MRP
-	1950	SA	9 125 763	8	2,090

## Lindavia

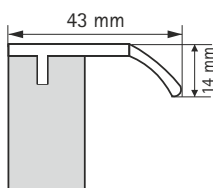

Details	Length (mm)	Finish	Article No.	PU	MRP
for 19 mm board	2000	SA	9 125 832	12	1,355

## Ticinum

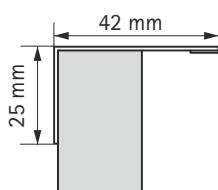



Details	Length (mm)	Finish	Article No.	PU	MRP
-	2000	SA	9 131 455	12	1,565

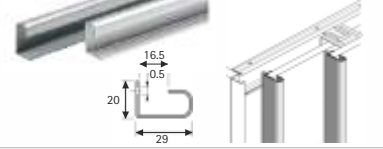
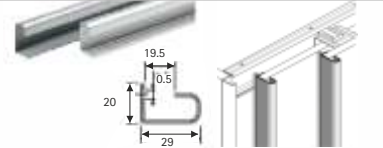
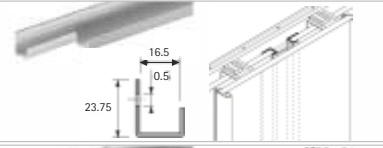
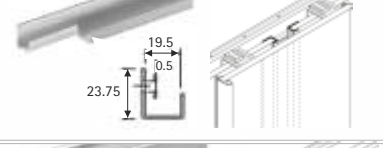
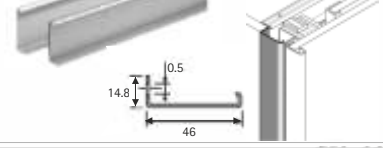
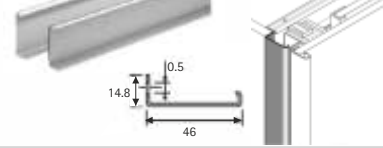
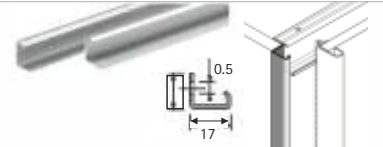
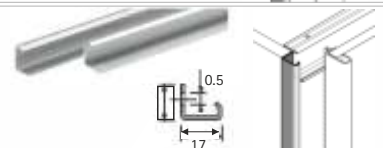

### Aluminium Door Profiles for 2/3 Sliding Door Carcasses

Description	Profile Section	Detail	Article No.	PU	MRP
Door Profile for door thick (15-16 mm)		Aluminium Silver Anodised Door Profile : 2050 mm (3 nos. for 2 door carcass ; 4 nos. for 3 door carcass)	9 117 416	4	2,440
Door Profile for door thick (18-19mm)		Aluminium Silver Anodised Door Profile : 2500 mm (3 nos. for 2 door carcass ; 4 nos. for 3 door carcass)	9 136 121	4	2,480
Door end Profile, U shape for door thick. 15-16 mm (Aluminium silver)		Aluminium Silver Anodised Door End Profile: 2050 mm ( 2 nos. for 3 door carcass)	9 117 420	4	2,050
Door end Profile, U shape for door thick. 18-19 mm (Aluminium silver)		Aluminium Silver Anodised Door End Profile: 2500 mm ( 2 nos. for 3 door carcass)	9 136 122	4	1,860
Carcass end Profile for Frontmost Door		Aluminium Silver Carcass End Profile (Frontmost Door) : 2100 mm (1 nos. for 2 door carcass ; 2 nos. for 3 door carcass)	9 117 463	4	2,240
Carcass end Profile for Frontmost Door		Aluminium Silver Carcass End Profile (Frontmost Door) : 2500 mm (1 nos. for 2 door carcass ; 2 nos. for 3 door carcass)	9 146 624	04	2,240
Carcass end Profile for Rearmost Door		Aluminium Silver Carcass End Profile (Rearmost Door) : 2100 mm (1 nos. for 2 door carcass)	9 117 462	4	1,480
Carcass end Profile for Rearmost Door		Aluminium Silver Carcass End Profile (Rearmost Door) : 2500 mm (1 nos. for 2 door carcass)	9 146 622	4	1,470

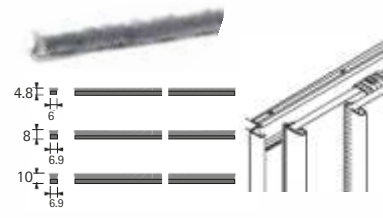
### Accessories for Aluminium Sliding Door Profiles



Description	Profile Section	Detail	Length (mm)	Ht. (mm)	Article no.	PU	MRP
Brush Sealing Strip (Self Adhesive)		Self Adhesive Brush Sealing Strip (Grey) 3 nos. for 2 door carcass; 4 nos. for 3 door carcass	2500	8	9 200 386	1	270
Brush Sealing Strip (Screw on)		Screw on Brush Sealing Strip (Brown)	2500	27	0 026 453	4	1,540

## Connectors for All Profiles



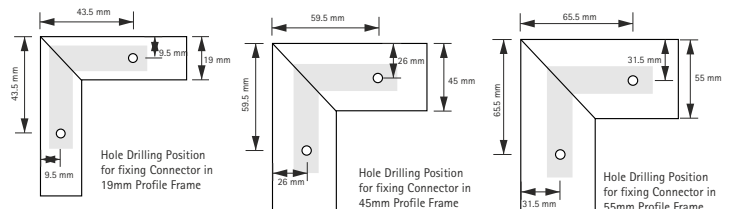



- Connectors to be procured separately with each Profile
- It is used to fix Profiles at 90° angle as shown in below figure





Description	Article No.	PU	MRP
Angle Connector Set (For all aluminium frame Profiles) - 1 Set consists of 4 connectors & 8 Screws	9 303 247	30	142
Mid Way Joining Profile Connector Set 	9 308 603	10	106
Bracket for sink counter Profile left 	9 293 678	50	26
Bracket for sink counter Profile right 	9 293 699	50	26

## Gola Profile Accessories



Description	Profile Section	Compatible with	Side	Article No.	PU	MRP
Gola Profile End Cap for C Type with screws 		SA & CP	Left	9 212 563	20	277
			Right	9 212 564	20	277
		SS	Left	9 218 244	20	278
			Right	9 218 245	20	278
		BL	Left	9 299 044	20	305
			Right	9 299 045	20	305
Gola Profile End Cap for L Type with screws 		SA & CP	Left	9 212 565	20	277
			Right	9 212 566	20	277
		SS	Left	9 218 246	20	278
			Right	9 218 247	20	278
		BL	Left	9 299 042	20	305
			Right	9 299 043	20	305
DC	Left	9 310 762	20	305		
	Right	9 310 763	20	305		
Gola Outer Angle Profile Connector with screws 		SA & CP		9 212 567	20	331
		SS		9 218 248	20	331
		BL		9 299 046	20	328
		DC		9 310 764	20	362
Gola Inner Angle Profile Connector with screws 		SA & CP		9 212 568	20	484
		SS		9 218 269	20	484
		BL		9 299 047	20	474
		DC		9 310 765	20	505
Gola L Connector set with screws 		-		9 220 600* / 9 333 566	50	47

● SA - Silver finish ● SS - Stainless steel finish ● BL - Black finish ● CP - Chrome finish ● DC - Dark Champagne finish

### Hinges for 19 mm Aluminium Profile

Description	Images	Item Details	Article No.	Unit	PU	MRP
Intermat 9936 (Opening Angle 95°)		Base 13.5 (Crank 0°) with Mounting Plate (D 0 mm)	9 242 896	Set	10	578
		9.5 Crank Intermat 9936 with Mounting Plate (Child Code)	9 242 898	Set	10	610
		16 Crank Intermat 9936 with Mounting Plate (Child Code)	1064108 + 1071605	Pc	50	256 + 30
Sensys 8638i (Opening Angle 95°)		0 Crank Sensys 8638i with Mounting Plate	9 243 057	Set	50	1,062
Obsidian Black Sensys 8638i (Opening angle 95°)		0 Crank Obsidian Black Sensys 8638i (Order mounting plate separately)	9 091 744	Pc	50	670

### Hinges for 45 mm and 55 mm Aluminium Profile

Onsys 4447i (Opening Angle 105°)		Onsys Hinge - 25 mm - 0 Crank with ounting plate and cover caps	9 281 432	Set	50	342
		Onsys Hinge - 25 mm - 9.5 Crank with mounting plate and cover caps	9 281 434	Set	50	376
		Onsys Hinge - 25 mm - 16 Crank with mounting plate and cover caps	9 281 436	Set	50	410
Sensys 8645i (Opening Angle 110°)		0 Crank Sensys 8645i with Mounting Plate	9 242 922	Set	100	690
		9.5 Crank Sensys 8645i with Mounting Plate	9 242 923	Set	100	728
		16 Crank Sensys 8645i with Mounting Plate	9 242 924	Set	100	768
Obsidian Black Sensys 8645i (Opening Angle 110°)		0 Crank with Mounting Plate Et Cover cap	9 323 480	Set	100	1,152
		9.5 Crank with Mounting Plate Et Cover cap	9 323 561	Set	100	1,208
		16 Crank with Mounting Plate Et cover cap	9 323 562	Set	100	1,262

# Notes

A series of horizontal dotted lines for writing notes.



**Registered & Head Office:****Hettich India Private Limited**

302, Durolite House,  
Opp. SAB TV, New Link Road,  
Andheri (West), Mumbai - 400 053  
Phone: +91 22 2674 3289/3356/4089

**Delhi Office:****Hettich India Private Limited**

A-26/4, 1st floor,  
Mohan Co-operative Industrial Estate,  
New Delhi - 110 044  
Phone: +91 11 4889 4000, 4889 4005

**Production Site – Vadodara:****Hettich India Private Limited**

Plot No. 304, Dhanora,  
Nandesari Road,  
Near ECPL,  
Village – Dhanora – 391 346  
Dist. – Vadodara, Gujarat

**Production Site – Indore:****Hettich India Private Limited**

Plot No 1, Sector 5,  
Mhow – Neemuch Road,  
Opp Lupin Ltd, Pithampur Industrial,  
Pithampur – 454 774  
Madhya Pradesh

08\_2023

**Application Centres:****Bengaluru:**

Adventz Center, Ground Floor 28,  
Cubbon Road, Shivaji Nagar,  
Bengaluru - 560 001  
Ph. No. : +91 91 3601 6413

**Mumbai:**

202/302, Durolite House, Opp. SAB TV,  
New Link Road, Andheri (West),  
Mumbai - 400 053  
Ph.No. : +91 22 2639 9707

**New Delhi:**

61, Punchkuian Road,  
Near RK Ashram Metro,  
Opposite Pillar No 4,  
New Delhi -110001,  
Ph. No. : +91 11 4750 8320

**Chennai:**

"Heavitree", Ground Floor,  
47, Spur Tank Road,  
Chetpet, Chennai - 600 031  
Ph. No. : +91 44 4263 7227

**Ahmedabad:**

1st Floor, Unit No. 102,  
Safal Pegasus, Anand Nagar,  
Ahmedabad - 380 015,  
Ph. No. : +91 79 4032 2824  
+91 84 4838 5318

**Gurugram:**

Global Business Park, Tower – A, 5th Floor,  
Mehrauli-Gurgaon Rd, Sikanderpur,  
Sector 26, Gurugram, Haryana 122 002.  
Ph. No. : +91 124 4221670

**Hyderabad:**

"Sai Krishna"  
797 – A, 2nd Floor,  
Road No. 36, Jubilee Hills,  
Hyderabad - 500 034  
Ph. No. : +91 40 2355 8994

**Indore:**

Office No.106 and 107-A,  
"Brilliant Titanium",  
Plot No.9, Scheme No.78, Part-II,  
Indore - 452 010  
Ph. No. : +91 96 9168 4480

**Chandigarh:**

2nd Floor, Aspire Tower, Plot no. 55,  
Industrial & Business park, Phase 1,  
Chandigarh - 160 002  
Ph. No. : +91 172 5012 347

**Kochi:**

41/2062D, 2nd Floor  
Palarivattom signal  
junction, NH 47 By-pass,  
Kochi - 682 028  
Ph. No. : +91 48 4402 8242

**Pune:**

Server Spacer ,  
Survey No. 127/1A ,  
Plot No. 8, Off. ITI Road, Aundh,  
Pune - 411 007  
Ph. No : +91 72 0847 6557

**Kolkata:**

2nd Floor, Unit Number 2A,  
Tirumala 22, East Topsia Road,  
At Topsia Tangra Crossing  
Kolkata - 700 046  
Ph. No. : +91 98310 12054

**Enquiry & Customer Services**

Toll Free : 1800 209 2096 (office hours)  
Email: sales\_enquiry@in.hettich.com  
customer\_services@in.hettich.com  
[www.hettich.com](http://www.hettich.com)

**Training Centre Address:**

Hettich Poddar Wood Work Institute  
Plot No.2, 1st Floor, DLF Industrial Estate-1  
Near NHPC Metro Station,  
Faridabad- Haryana  
Ph: +91 129 4203888  
Email: info@hpwwi.com

Follow Hettich India

