



TopLine & SlideLine sliding door systems /
WingLine L folding door system:
Quick finder / Range summaries

Technik für Möbel

Hettich

Sliding door system / top running

- ▶ TopLine XL / overlay door position
- ▶ Performance summary



Technical details in brief

- ▶ 2-track, top running sliding door system
- ▶ Overlay door position
- ▶ For wooden doors or wood / aluminium framed doors
- ▶ Door weight up to 80 kg
- ▶ Door height up to 2600 mm
- ▶ Door width 700 - 2000 mm
- ▶ Door thicknesses 16, 18, 19, 22, 25, 28, 30, 33, 40, 50 mm
- ▶ Height adjustment ± 2 mm
- ▶ Door height, door offset and door overlay can be adjusted
- ▶ Easy to open as a result of minimal opening resistance
- ▶ Silent System in closing, opening and colliding direction
- ▶ Fast installation runner systems and Silent Systems
- ▶ Tested to DIN EN 15706, Level 3

Door format and door weight

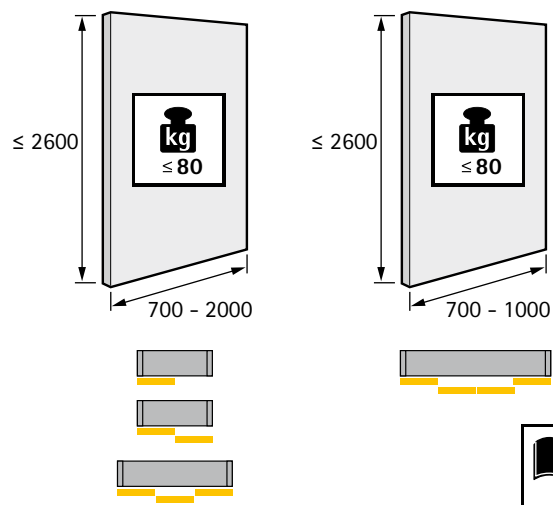

Door material

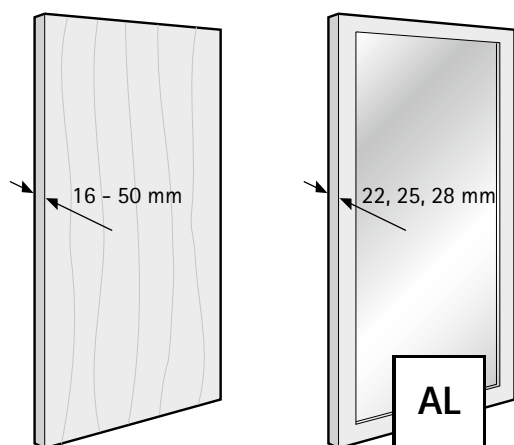

Number of door wings and door position

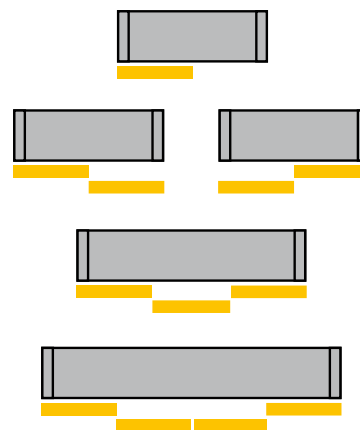

Silent System

	1-door	2-door	3-door	4-door
Soft closing				
Soft opening				
Soft colliding				

Sliding door system / top running

- ▶ TopLine XL / overlay door position
- ▶ System component quick finder



TopLine XL Fitting sets					
	Door thickness mm	Left hand rear most door set	Right hand rear most door set	Set for front most door	Soft guiding set
		9 181 744	or 9 183 533		9 181 696
	19	9 181 744		9 181 742	9 169 548
	22	9 181 744		9 183 613	9 169 548
	28	9 181 744		9 183 615	9 169 548
	33	9 181 744		9 193 053	9 169 548
	40	9 181 744		9 183 616	9 169 548
	50	9 181 744		9 183 617	9 169 548
	19		9 183 533	9 181 742	9 169 548
	22		9 183 533	9 183 613	9 169 548
	28		9 183 533	9 183 615	9 169 548
	33		9 183 533	9 193 053	9 169 548
	40		9 183 533	9 183 616	9 169 548
	50		9 183 533	9 183 617	9 169 548
	19	9 181 744	9 183 533	9 181 742	9 154 933* or 9 169 547**
	22	9 181 744	9 183 533	9 183 613	9 154 933* or 9 169 547**
	28	9 181 744	9 183 533	9 183 615	9 154 933* or 9 169 547**
	33	9 181 744	9 183 533	9 193 053	9 154 933* or 9 169 547**
	40	9 181 744	9 183 533	9 183 616	9 154 933* or 9 169 547**
	50	9 181 744	9 183 533	9 183 617	9 154 933* or 9 169 547**
	19	9 181 744	9 183 533	9 181 742 + 9 196 841	9 185 664
	22	9 181 744	9 183 533	9 183 613 + 9 199 006	9 185 664
	28	9 181 744	9 183 533	9 183 615 + 9 199 007	9 185 664
	33	9 181 744	9 183 533	9 193 053 + 9 199 008	9 185 664
	40	9 181 744	9 183 533	9 183 616 + 9 199 009	9 185 664
	50	9 181 744	9 183 533	9 183 617 + 9 199 010	9 185 664
	19	9 181 744	9 183 533	9 181 742 (x 2)	9 169 548 (x 2)
	22	9 181 744	9 183 533	9 183 613 (x 2)	9 169 548 (x 2)
	28	9 181 744	9 183 533	9 183 615 (x 2)	9 169 548 (x 2)
	33	9 181 744	9 183 533	9 193 053 (x 2)	9 169 548 (x 2)
	40	9 181 744	9 183 533	9 183 616 (x 2)	9 169 548 (x 2)
	50	9 181 744	9 183 533	9 183 617 (x 2)	9 169 548 (x 2)

* in combination with set of runner profiles, ** in combination with set of reinforced runner profiles

	Article	Length mm	Order no.
	Runner profile set 1 / 2 / 3 door	3000	9 135 002
		4000	9 135 004
		6000	9 155 340
	Set of runner profiles, reinforced 1 / 2 / 3 / 4 door For clipping	3000	9 199 062
		4000	9 199 063
		6000	9 199 064
	Set of runner profiles, reinforced 1 / 2 / 3 / 4 door Predrilled	3000	9 191 156
		4000	9 191 157
		6000	9 191 158

Article	Order no.
Cover profile	9 137 352
Set for clip on installation	9 197 185
Profile attachment, 16-19 mm panel thickness	9 130 078
Profile attachment, 20-22 mm panel thickness	9 180 317
Profile attachment, 22-25 mm panel thickness	9 180 318
Drilling jig	9 162 438
Adjustment fitting, plastic	0 045 198
Adjustment fitting	9 252 651

Sliding door system / top running

- ▶ TopLine L / overlay door position / door movement in front of top panel
- ▶ Performance summary



Technical details in brief

- ▶ 2-track, top running sliding door system
- ▶ Overlay door position
- ▶ For wooden doors or wood / aluminium framed doors
- ▶ Door weight up to 50 kg
- ▶ Door height up to 2600 mm
- ▶ Door width 700 - 1500 mm
- ▶ Door thicknesses 16, 18, 19, 21, 22, 25, 40 mm
- ▶ +/- 3 mm height adjustment
- ▶ Door opening options: fully overlapping or offset when using projecting handles
- ▶ Fast installation of guide components
- ▶ Silent System in opening and closing direction
- ▶ Tested to DIN EN 15706, Level 3

Door format and door weight

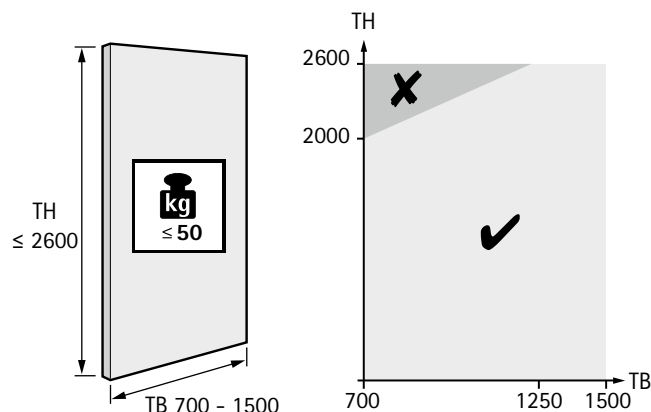

TB	700	800	900	1000	1100	1200	1250	...	1500
TH ≤	2000	2109	2218	2327	2436	2545	2600	...	2600



Door material

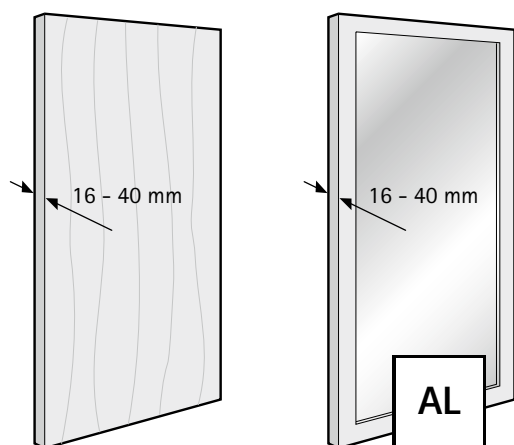

Number of door wings and door position

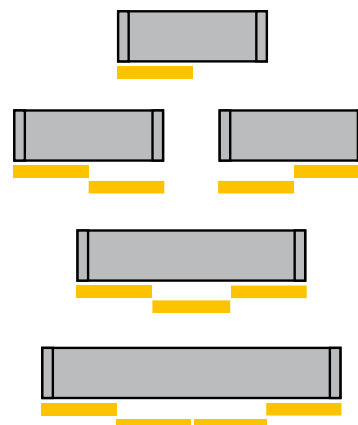

Silent System

	1-door	2-door	3-door	4-door
Soft closing				
Soft opening				

Sliding door system / top running

- ▶ TopLine L / overlay door position / door movement in front of top panel
- ▶ System component quick finder



TopLine L in front of top panel / offset opening / Silent System soft closing							
	Door thickness mm	Set for rear most door left	Set for rear most door right	Set for front most door	Accessories for offset opening	Soft closing set	Soft guiding set*
		9 206 505 or 9 206 506			9 206 309	9 169 651	
	16	9 206 505		9 206 483	9 206 309	9 169 651	9 199 769*
	19	9 206 505		9 206 500	9 206 309	9 169 651	9 199 769*
	22	9 206 505		9 206 501	9 206 309	9 169 651	9 199 769*
	25	9 206 505		9 206 502	9 206 309	9 169 651	9 199 769*
	40	9 206 505		9 206 503	9 206 309	9 169 652	9 199 769*
	16		9 206 506	9 206 483	9 206 309	9 169 651	9 199 769*
	19		9 206 506	9 206 500	9 206 309	9 169 651	9 199 769*
	22		9 206 506	9 206 501	9 206 309	9 169 651	9 199 769*
	25		9 206 506	9 206 502	9 206 309	9 169 651	9 199 769*
	40		9 206 506	9 206 503	9 206 309	9 169 652	9 199 769*
	16	9 206 505	9 206 506	9 206 483	9 206 310	9 169 653 + 9 140 438	9 199 769*
	19	9 206 505	9 206 506	9 206 500	9 206 310	9 169 653 + 9 140 438	9 199 769*
	22	9 206 505	9 206 506	9 206 501	9 206 310	9 169 653 + 9 140 438	9 199 769*
	25	9 206 505	9 206 506	9 206 502	9 206 310	9 169 653 + 9 140 438	9 199 769*
	40	9 206 505	9 206 506	9 206 503	9 206 310	9 169 653 + 9 140 438	9 199 769*
Synchronised 	16	9 206 505	9 206 506	9 206 483 (x 2)	9 206 309	9 169 651 + 9 169 653	9 199 769 (x 2)*
	19	9 206 505	9 206 506	9 206 500 (x 2)	9 206 309	9 169 651 + 9 169 653	9 199 769 (x 2)*
	22	9 206 505	9 206 506	9 206 501 (x 2)	9 206 309	9 169 651 + 9 169 653	9 199 769 (x 2)*
	25	9 206 505	9 206 506	9 206 502 (x 2)	9 206 309	9 169 651 + 9 169 653	9 199 769 (x 2)*
	40	9 206 505	9 206 506	9 206 503 (x 2)	9 206 309	9 169 652 + 9 169 653	9 199 769 (x 2)*

* Article optional, instead of accessories, offset opening

	Article	Length mm	Order no.
	Runner profile	3000	0 071 111
		6000	0 045 118
	Runner profile set 4-door, synchronised	3000	9 185 714
		4000	9 185 715

Article	Order no.
Cover profile, grey	0 041 184
Cover profile, brown	0 046 418
Profile marking template	9 190 925
Drilling jig	9 186 075
Adjustment fitting, plastic	0 045 198
Adjustment fitting	9 252 651

	Article	Length mm	Order no.
	STB 11 guide profile	3000	0 071 117
		6000	0 046 419

Sliding door system / top running

- ▶ TopLine L / overlay door position / door movement in front of top panel
- ▶ System component quick finder



TopLine L in front of top panel / offset opening / Silent System soft closing and soft opening

	Door thickness mm	Set for rear most door left	Set for rear most door right	Set for front most door	Soft closing set	Soft opening set	Soft guiding set
		9 206 505 or 9 206 506			9 169 651		
	16	9 206 505		9 206 483	9 169 651	9 169 637	9 199 769
	19	9 206 505		9 206 500	9 169 651	9 169 637	9 199 769
	22	9 206 505		9 206 501	9 169 651	9 169 637	9 199 769
	25	9 206 505		9 206 502	9 169 651	9 169 637	9 199 769
	40	9 206 505		9 206 503	9 169 652	9 169 637	9 199 769
	16		9 206 506	9 206 483	9 169 651	9 169 637	9 199 769
	19		9 206 506	9 206 500	9 169 651	9 169 637	9 199 769
	22		9 206 506	9 206 501	9 169 651	9 169 637	9 199 769
	25		9 206 506	9 206 502	9 169 651	9 169 637	9 199 769
	40		9 206 506	9 206 503	9 169 652	9 169 637	9 199 769
	16	9 206 505	9 206 506	9 206 483	9 169 653 + 9 140 438	9 169 656	9 199 769
	19	9 206 505	9 206 506	9 206 500	9 169 653 + 9 140 438	9 169 656	9 199 769
	22	9 206 505	9 206 506	9 206 501	9 169 653 + 9 140 438	9 169 656	9 199 769
	25	9 206 505	9 206 506	9 206 502	9 169 653 + 9 140 438	9 169 656	9 199 769
	40	9 206 505	9 206 506	9 206 503	9 169 653 + 9 140 438	9 169 656	9 199 769
Synchronised 	16	9 206 505	9 206 506	9 206 483 (x 2)	9 169 651 + 9 169 653	9 169 637	9 199 769 (x 2)
	19	9 206 505	9 206 506	9 206 500 (x 2)	9 169 651 + 9 169 653	9 169 637	9 199 769 (x 2)
	22	9 206 505	9 206 506	9 206 501 (x 2)	9 169 651 + 9 169 653	9 169 637	9 199 769 (x 2)
	25	9 206 505	9 206 506	9 206 502 (x 2)	9 169 651 + 9 169 653	9 169 637	9 199 769 (x 2)
	40	9 206 505	9 206 506	9 206 503 (x 2)	9 169 652 + 9 169 653	9 169 637	9 199 769 (x 2)

	Article	Length mm	Order no.
	Runner profile	3000	0 071 111
		6000	0 045 118
	Runner profile set 4-door, synchronised	3000	9 185 714
		4000	9 185 715

Article	Order no.
Cover profile, grey	0 041 184
Cover profile, brown	0 046 418
Profile marking template	9 190 925
Drilling jig	9 186 075
Adjustment fitting, plastic	0 045 198
Adjustment fitting	9 252 651

	Article	Length mm	Order no.
	STB 11 guide profile	3000	0 071 117
		6000	0 046 419

Sliding door system / bottom running

- ▶ SlideLine M / overlay door position / 1-track
- ▶ Performance summary



Technical details in brief

- ▶ 1-track, bottom running sliding door system
- ▶ Overlay door position
- ▶ Wooden, glass or aluminium framed doors
- ▶ Door weight up to 30 kg
- ▶ Door height up to 2000 mm
- ▶ Door width from 300 - 1800 mm
- ▶ Shelf thicknesses 15, 16, 18, 19, 22, 25 mm
- ▶ +/- 2 mm height adjustment
- ▶ Silent System in closing, opening and colliding direction
- ▶ Tool-less fast installation of the front panel
- ▶ Tested to EN 15706, Level 1 or 3

Door format and door weight

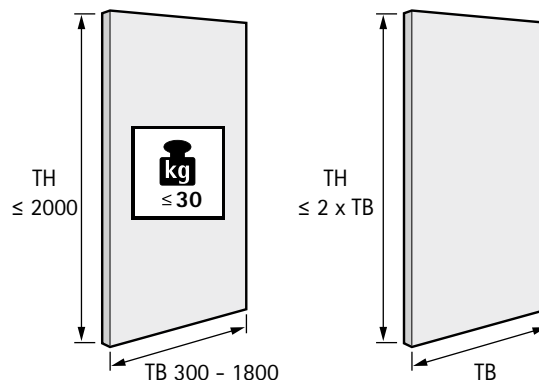

TB	300	400	500	600	700	800	900	1000	...	1800	
TH ≤	600	800	1000	1200	1400	1600	1800	2000	...	2000	

Door material

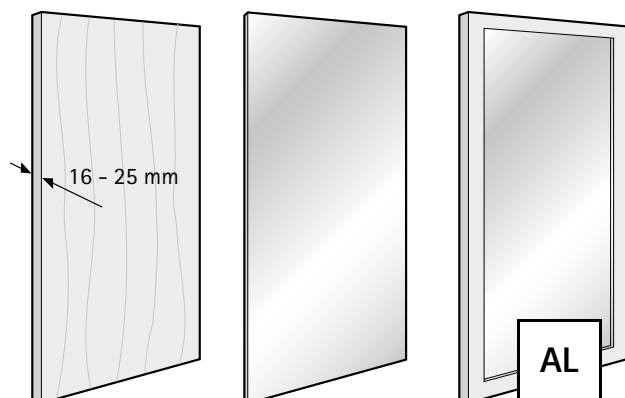

Number of door wings and door position

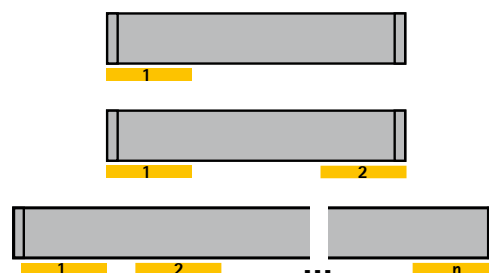

Silent System

	1-door	with several doors
Soft closing		
Soft opening		
Soft colliding		

Sliding door system

- ▶ SlideLine M / overlay door position / 1-track
- ▶ System components



Application for SlideLine M, 1-track

Fitting sets

Image	Sensor technology	Order no. / Version				PU
		Set of wooden doors	Upgrade set for bonded glass doors	Upgrade set for screw mounted 6 mm glass doors	Upgrade set for 19 mm aluminium frame doors	
	for doors without Silent System	9 156 339	-	9 184 596	9 184 629	1 set
	for doors up to 10 kg with Silent System	9 201 921	9 184 566	9 184 595	9 184 626	1 set
	for doors up to 30 kg with Silent System	9 156 338	9 184 566	9 184 595	9 184 626	1 set

Profile sets (2 profiles in a set, aluminium, silver anodised)

Image	Length mm	Height mm	Order no.	PU
	2500	15 / 16	9 209 165	1 set
	4000	15 / 16	9 209 166	1 set
	2500	18 / 19	9 209 167	1 set
	4000	18 / 19	9 209 218	1 set
	2500	22	9 209 219	1 set
	4000	22	9 209 220	1 set
	2500	25	9 209 221	1 set
	4000	25	9 209 222	1 set

Add on profile sets (1 profile in a set, aluminium, silver anodised)

Image	Length mm	Height mm	Order no.	PU
	2500	15 / 16	9 209 223	1 set
	4000	15 / 16	9 209 224	1 set
	2500	18 / 19	9 209 225	1 set
	4000	18 / 19	9 209 226	1 set
	2500	22	9 209 228	1 set
	4000	22	9 209 229	1 set
	2500	25	9 209 230	1 set
	4000	25	9 209 231	1 set

Coloured sets for concealing the runner profiles with a coloured cover

Image	Length mm	Height mm	Order no. / colour				PU
			silver	black	white	champagne	
	2500	15 / 16	9 209 232	9 209 269	9 209 272	9 209 274	1 set
	4000	15 / 16	9 209 268	9 209 271	9 209 273	9 209 275	1 set
	2500	18 / 19	9 209 277	9 209 279	9 209 281	9 209 284	1 set
	4000	18 / 19	9 209 278	9 209 280	9 209 283	9 209 285	1 set
	2500	22	9 209 286	9 209 308	9 209 310	9 209 312	1 set
	4000	22	9 209 287	9 209 309	9 209 311	9 209 313	1 set
	2500	25	9 209 399	9 209 402	9 209 404	9 209 406	1 set
	4000	25	9 209 400	9 209 403	9 209 405	9 209 407	1 set

Sliding door system / bottom running

- ▶ SlideLine M / inset door position / 2-track
- ▶ Performance summary



Technical details in brief

- ▶ 1 or 2-track bottom running sliding door system
- ▶ Inset door position
- ▶ Wooden doors
- ▶ 1-door, 2-door or 3-door application
- ▶ Runner and guide profile for screwing on or pressing in
- ▶ Door weight up to 30 kg
- ▶ Door height up to 2000 mm
- ▶ Door width from 300 - 1800 mm
- ▶ +/- 2 mm height adjustment
- ▶ Silent System in closing, opening and colliding direction
- ▶ Door quickly mounted without the need for tools
- ▶ Tested to EN 15706, Level 3

Door format and door weight

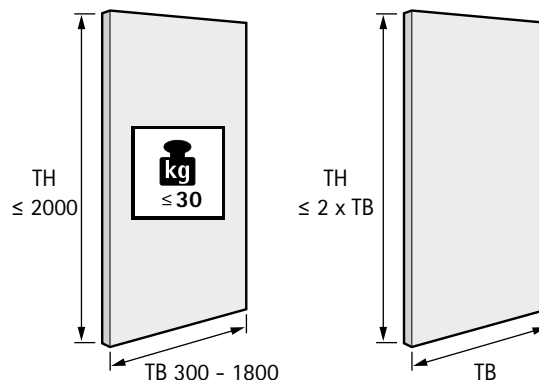

TB	300	400	500	600	700	800	900	1000	...	1800	
TH ≤	600	800	1000	1200	1400	1600	1800	2000	...	2000	

Door material

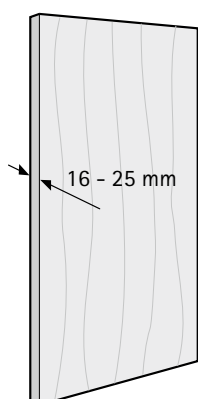

Number of door wings and door position

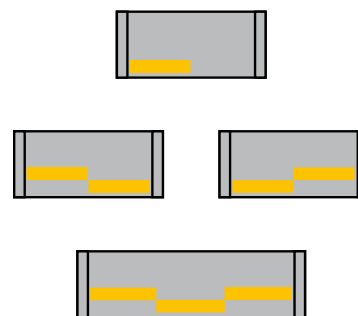

Silent System

	1-door	2-door	3-door	
Soft closing				
Soft opening				
Soft colliding				

Sliding door system

- ▶ SlideLine M / inset door position / 2-track
- ▶ System components



Application for SlideLine M, 2-track

Fitting sets

Image	Application	Order no. / Version Set of wooden doors	PU
	Set of fittings for doors without Silent System	2 x 9 156 339	1 set
	Set of fittings for doors up to 10 kg with Silent System	2 x 9 201 921	1 set
	Set of fittings for doors up to 30 kg with Silent System	2 x 9 156 338	1 set

Runner profiles (aluminium, silver anodised)

Image	Version	Mounting	Length mm	Order no.	PU
	Set of profiles, 2-track	for gluing on / for screwing on	2500	9 227 245	1 set
	Set of profiles, 1-track	linear mounting plate	2500	9 227 246	1 set
	2-track	for screwing on in the screw slot / for gluing on	2500	9 227 186	1/100 each
			4000	9 236 576	1/100 each
	2-track	for screwing on	2500	9 227 183	1/100 each
	1-track	linear mounting plate	2500	9 227 188	1/100 each
			4000	9 239 329	1/100 each

Optional system accessories

Double sided adhesive tape

Image	Description	Length m	Order no.	PU
	▶ For 2-track runner profile	25	9 227 006	1 set

Fixing screws

Image	Description	Shelf thickness mm	Order no.	PU
	▶ For 2-track runner profile	16	9 229 240	1 set
		18 - 19	9 229 241	1 set
		25	9 229 243	1 set

Door stop / spacer

Image	Description	Order no.	PU
	▶ For screwing on	9 115 216	1/100 each
		9 102 993	500 ea.

Folding door system

- ▶ WingLine L / attached to the side
- ▶ Performance summary



Technical details in brief

- ▶ For one folding door with 2 wings
- ▶ Overlay door position
- ▶ For wooden doors
- ▶ Push / Pull to move
- ▶ It is recommended to use the Sensys hinge
- ▶ Door wing weight up to 25 kg
- ▶ Door height up to 2400 mm
- ▶ Door wing width up to 600 mm
- ▶ Tested with 40000 cycles

Door format and door weight

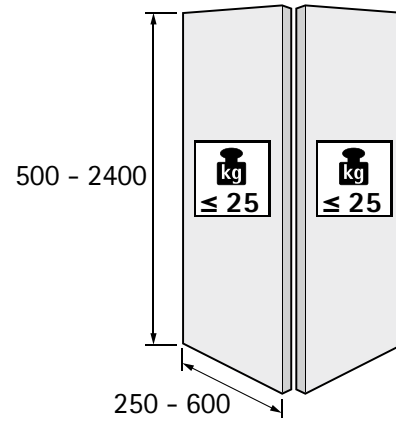

Door material

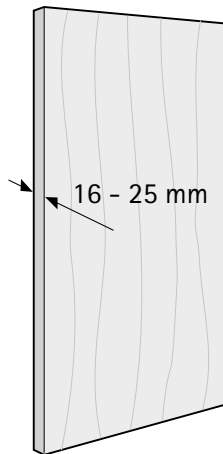

Number of door wings and door position

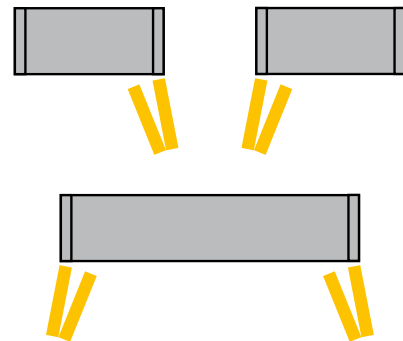

Door protrusion

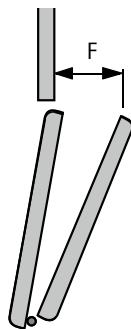

Recommended number of cabinet body and folding door hinges

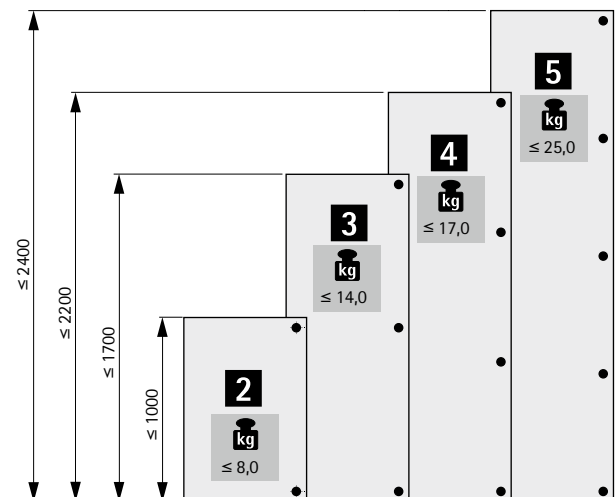

Folding door system

- ▶ WingLine L / attached to the side
- ▶ System summary



The new multifolder: WingLine L

Runner and guide profiles

- Runner profile
- Guide profile for installing on the plinth or under the plinth

Push to move/Pull to move

- Mechanical, soft opening of the door panel set
- 3 force options depending on door panel width and weight

Runners

- Tool-less fast installation
- Running component for door panel weight up to 25 kg
- Running component for door panel weight up to 12 kg

Guide component

- Tool-less fast installation
- Installation on the plinth
- Installation under the plinth

Push to move

- Reliably keeps the door closed

Carcase hinges

- Sensys 110° or 95°, with or without self closing feature

Intelligent installation accessories

- Profile installation
- Positioning centre hinges
- Positioning Push/Pull to move

Centre hinge

- 2 part
- Tool-less fast installation

Folding door system

- ▶ WingLine L / attached to the side
- ▶ Selection guide



The following planning information is required for selecting the correct WingLine L articles in just a few easy steps:

- ▶ Number of folding doors
- ▶ Door wing width (mm)
- ▶ Door wing weight (kg)

Only a few clicks away to the folding door cabinet or wardrobe.



<https://www.hettich.com/short/59ada1>

Opening assistance required? Classic front with handle or purist look without handles?		Is spring assisted self closing feature needed in the hinge and in the running and guide components?	
Door with handle	Door without handle	Opening mechanism	Self-closing feature
· Pull to move	· Push to move	Push to move	No self closing feature
· Pull to move Silent		Pull to move	No self closing feature
· No opening assistance		Pull to move Silent	With self closing feature
		No opening mechanism	With self closing feature
What opening force is needed for Push / Pull / Pull to move Silent?		Is a bottom door guide required?	
		Door wing weight up to 12 kg	Bottom door guide: optional
		From a door wing weight of 12 kg	Bottom door guide: recommended
		Where will the bottom door guide be positioned?	
		Cabinet with plinth	Guide profile underneath bottom panel
		Cabinet without plinth	Guide profile on front of bottom panel
			Guide profile underneath structural panel

Opening assistance required? Classic front with handle or purist look without handles?

Pull to move and Push to move are two innovative and unique opening mechanisms for folding door systems. A slight pull on the handle or gentle push on the (handleless) front automatically opens the door all the way, taking it to the open position in a cushioned movement. A fascinating opening effect that works all mechanically! This means it requires neither cables nor any connection to the power supply.

Door with handle

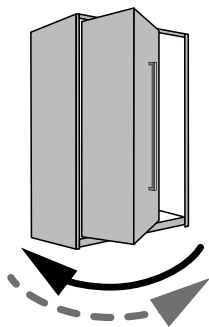

No opening mechanism
The door is opened and closed by hand.

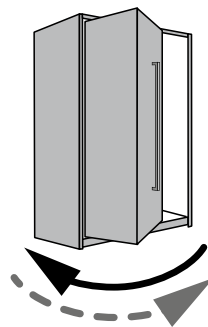

Pull to move
The door opens automatically from a 1° opening angle in response to a minimal pull on the handle and is returned to the closed position by hand.

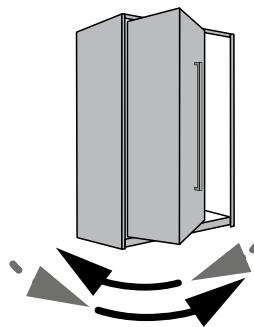

Pull to move Silent
The door opens automatically from a 35° opening angle in response to a slight pull on the handle and is returned to the closed position in a cushioned movement.

Door without handle

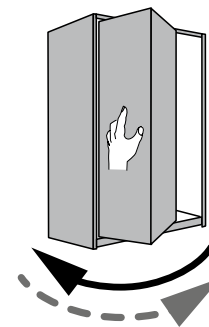

Push to move
The door opens automatically in response to a light press on the front and is returned to the closed position by hand.

Folding door system

- ▶ WingLine L / attached to the side
- ▶ Selection guide



What influence do different cabinet body hinges have on door protrusion?

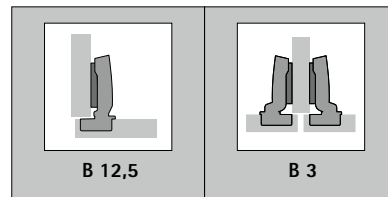
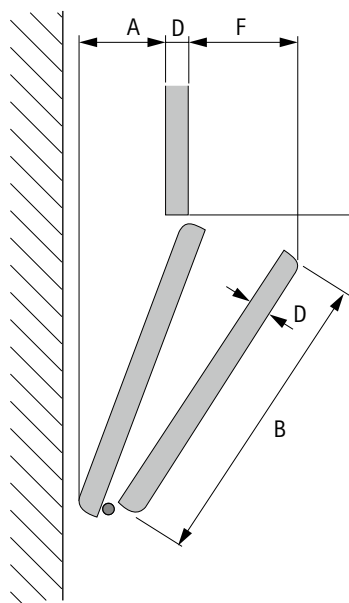

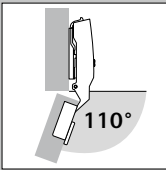
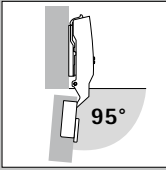
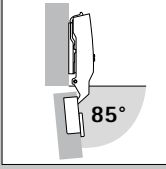
	D	B	B 12,5		B 3	
			A	F	A	F
 <p>Sensys 8645i / 8675 (effective opening angle = 100°)</p>	16	250	31	58	21	68
		300	41	58	32	68
		450	73	58	63	68
		600	104	58	94	68
	18 / 19	250	31	61	21	71
		300	41	61	32	71
		450	73	61	63	71
		600	104	61	94	71
	22	250	31	64	21	74
		300	41	64	32	74
		450	73	64	63	74
		600	104	64	94	74
25	250	31	67	21	77	
	300	41	67	32	77	
	450	73	67	63	77	
	600	104	67	94	77	
 <p>Sensys 8631i / 8631 *</p>	16	250	13	70	4	79
		300	18	72	8	82
		450	31	78	21	87
		600	44	82	34	91
	18 / 19	250	13	73	4	82
		300	18	75	8	84
		450	31	81	21	90
		600	44	84	34	94
	22	250	13	74	4	85
		300	18	78	8	87
		450	31	84	21	93
		600	44	87	34	97
25	250	13	78	4	88	
	300	18	81	8	90	
	450	31	86	21	96	
	600	44	90	34	100	
 <p>Sensys 8645i / 8675 with opening angle limiter 85° *</p>	16	250		115		125
		300		127		136
		450		159		169
		600		190		200
	18 / 19	250		118		128
		300		130		139
		450		162		172
		600		193		203
	22	250		121		131
		300		133		142
		450		165		175
		600		196		205
25	250		124		133	
	300		136		145	
	450		168		178	
	600		199		208	

* Restriction of the soft opening at reduced opening angles of 95° or 85°.

Folding door system

- ▶ WingLine L / attached to the side
- ▶ Quick finder



Fitting sets for set of folding doors, left

	Set of fittings	Order no.
	25 kg without self closing feature	9 237 880
	25 kg with self closing feature	9 237 852
	12 kg with self closing feature, with bottom guide	9 237 882
	12 kg with self closing feature, without bottom guide	9 237 903
	12 kg without self closing feature, with bottom guide	9 237 905
	12 kg without self closing feature, without bottom guide	9 237 901

Fitting sets for set of folding doors, right

	Set of fittings	Order no.
	25 kg without self closing feature	9 237 881
	25 kg with self closing feature	9 237 890
	12 kg with self closing feature, with bottom guide	9 237 906
	12 kg with self closing feature, without bottom guide	9 237 902
	12 kg without self closing feature, with bottom guide	9 237 904
	12 kg without self closing feature, without bottom guide	9 237 900

Fitting sets for sets of folding doors, left / right

	Set of fittings	Order no.
	25 kg without self closing feature	9 237 880 + 9 237 881
	25 kg with self closing feature	9 237 852 + 9 237 890
	12 kg with self closing feature, with bottom guide	9 237 882 + 9 237 906
	12 kg with self closing feature, without bottom guide	9 237 903 + 9 237 902
	12 kg without self closing feature, with bottom guide	9 237 905 + 9 237 904
	12 kg without self closing feature, without bottom guide	9 237 901 + 9 237 900

Folding door system

- ▶ WingLine L / attached to the side
- ▶ Quick finder



User convenience units for set of folding doors, left

Push to move set			Pull to move Silent set			Pull to move set		
light*	medium weight*	heavy*	light*	medium weight*	heavy*	light*	medium weight*	heavy*
-	9 238 051	9 238 052	-	-	-	-	9 238 115	9 238 125
-	-	-	-	9 238 121	9 238 123	-	-	-
-	-	-	9 238 120	9 238 121	-	-	-	-
-	-	-	9 238 120	9 238 121	-	-	-	-
9 238 102	9 238 051	-	-	-	-	9 238 117	9 238 115	-
9 238 102	9 238 051	-	-	-	-	9 238 117	9 238 115	-

User convenience units for set of folding doors, right

Push to move set			Pull to move Silent set			Pull to move set		
light*	medium weight*	heavy*	light*	medium weight*	heavy*	light*	medium weight*	heavy*
-	9 238 101	9 238 053	-	-	-	-	-	9 238 114
-	-	-	-	-	9 238 122	-	-	-
-	-	-	9 238 119	9 238 124	-	-	-	-
-	-	-	9 238 119	9 238 124	-	-	-	-
9 238 113	9 238 101	-	-	-	-	9 238 118	9 238 116	-
9 238 113	9 238 101	-	-	-	-	9 238 118	9 238 116	-

User convenience units for set of folding doors, left / right

Push to move set			Pull to move Silent set			Pull to move set		
light*	medium weight*	heavy*	light*	medium weight*	heavy*	light*	medium weight*	heavy*
-	9 238 051 + 9 238 101	9 238 052 + 9 238 053	-	-	-	-	-	9 238 125 + 9 238 114
-	-	-	-	-	9 238 123 + 9 238 122	-	-	-
-	-	-	9 238 120 + 9 238 119	9 238 121 + 9 238 124	-	-	-	-
-	-	-	9 238 120 + 9 238 119	9 238 121 + 9 238 124	-	-	-	-
9 238 102 + 9 238 113	9 238 051 + 9 238 101	-	-	-	-	9 238 117 + 9 238 118	9 238 115 + 9 238 116	-
9 238 102 + 9 238 113	9 238 051 + 9 238 101	-	-	-	-	9 238 117 + 9 238 118	9 238 115 + 9 238 116	-

* Legend, door weight / door width

Light version	Door weight up to 5 kg / door width up to 300 mm
Medium weight version	Door weight up to 12 kg / door width up to 450 mm
Heavy version	Door weight up to 25 kg / door width up to 600 mm

Folding door system

- ▶ WingLine L / attached to the side
- ▶ Quick finder



Mandatory system accessories

Profile set

Image	Description	Length mm	Order no.	PU
	▶ Aluminium, silver anodised	1200	9 239 311	1 set
		2400	9 239 310	1 set

Sensys 8645i fast assembly concealed hinge in combination with Pull to move Silent *

Image	Article	Order no.	PU
	Sensys 8645i, base 12.5 mm, TH 52 cup, for screwing on	9 073 605	1/50 ea.
	Cross mounting plate with expanding sockets and special screws, distance D = 1.5 mm	9 075 071	1/50 ea.
	Cover cap for Sensys hinge cup for TH / TS	9 088 251	1/50 ea.
	Cover cap for Sensys hinge arm (embossed with Hettich logo)	9 088 250	1/50 ea.

Sensys 8745 fast assembly concealed hinge in combination with Pull to move / Push to move *

Image	Article	Order no.	PU
	Sensys 8745, base 12.5 mm, TH 52 cup, for screwing on	9 073 662	1/50 ea.
	Cross mounting plate with expanding sockets and special screws, distance D = 1.5 mm	9 075 071	1/50 ea.
	Cover cap for Sensys hinge cup for TH / TS	9 088 251	1/50 ea.
	Cover cap for Sensys hinge arm (embossed with Hettich logo)	9 088 250	1/50 ea.

* For further Sensys hinges, see 2016 Furniture Fittings and Applications catalogue, volume 1, page 30 - 31*

Optional system accessories

Centre hinge

Image	Description	Order no.	PU
	<ul style="list-style-type: none"> ▶ With adjustable offset pivot ▶ For door thicknesses of 15 mm and over ▶ Gradual adjustment of the pivot offset with 3 mm and 6 mm 	0 046 787	1/10 each

Adjustment fitting

Image	Description	Order no.	PU
	<ul style="list-style-type: none"> ▶ For straightening distorted furniture doors ▶ Set of 2 	9 252 651	1 set

Mechanical stay closed function for Push to move



- ▶ Mechanism for keeping a door set closed when using Push to move
- ▶ Ideal for two door cabinet body constructions without centre panel
- ▶ Guide profile underneath structural panel
- ▶ Set contains all the parts required for keeping a two wing folding sliding door closed

Set comprises:

- ▶ 1 mechanical stay closed function
- ▶ 1 activator push rod
- ▶ Fixing material

- ▶ By way of option, the mechanical stay closed function can be used instead of the magnetic stay closed function contained in the set
- ▶ Using the mechanical stay closed function reduces the adjustment range of WingLine L from +/- 3 mm to +/- 2 mm

Colour	Order no.	PU
white	9 264 170	1/50 set
grey	9 264 191	1/50 set
black	9 264 192	1/50 set

Hettich Service: Expertise on the web



Hettich app:

Our app is available from the relevant online store



You will find the entire product range, further technical details and any additional information you require in the Hettich online catalogue.



Realise new furniture ideas cost effectively and constantly improve the tried and tested!

Hettich assists you online with finding ideas, planning specific cabinet bodies, selecting the right fittings and efficient realisation.

You will find a wealth of inspiration at www.hettich.com. The right fittings are quickly found in the online catalogue with everything from an initial overview of products to detailed information.

You can use various tools for accurately and easily planning furniture with Hettich fittings: cabinet body planning with HettichPlan, the Design Gallery with specific solutions for realising furniture as well as the Hettich CAD fittings library.

The Hettich Technical Assistant helps you with assembling and adjusting Hettich products.



www.hettich.com

Order no. 9.277 715
1906-028_SDS_Quickfinder_2019_HHE/en

Technik für Möbel

