

# Cadro frame system



For endlessly creative furniture ideas

Technik für Möbel

  
**Hettich**

## Cadro: the aluminium frame system for endlessly creative furniture ideas



- ▶ Suitable for use in any application
- ▶ Clean cut, reduced design
- ▶ Whether open or enclosed
- ▶ Wall fixed or floor standing
- ▶ Whether standing alone or embracing existing furniture

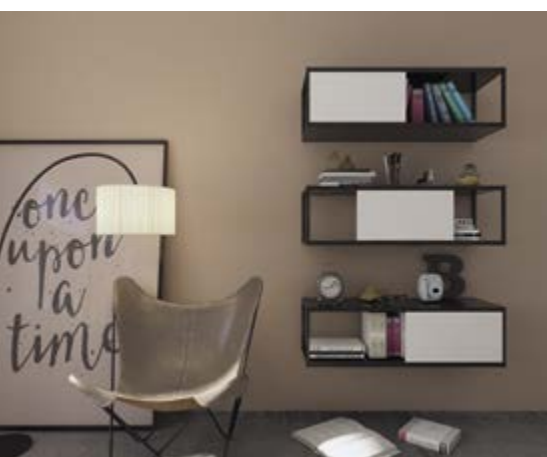
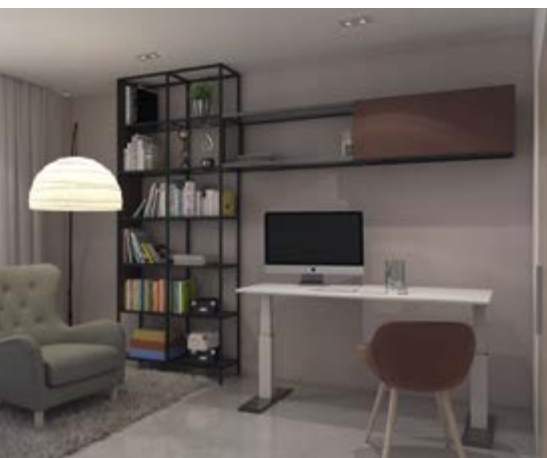

The Cadro aluminium frame system uses a variety of aluminium profiles and connecting nodes. The profiles are designed for 16 mm shelves made of materials, such as wood, or for 6 mm glass shelves. The system components are available in matt black. The Cadro assembly aid guarantees components are fitted quickly, easily and with absolute precision.

The system can be upgraded by adding:

- ▶ Feet or castors
- ▶ Matching handles
- ▶ A side hung door on Sensys hinge
- ▶ A sliding door with the SlideLine M fitting
- ▶ A closed drawer with AvanTech YOU



**Cadro:** the aluminium frame system that lets you design almost anything!



From open shelf unit to furniture that's completely enclosed by sliding doors, drawer systems or hinged doors. Endless scope for customised diversity and creativity.



Discover further creative furniture solutions and details on planning them for downloading from our design gallery at [www.hettich.com](http://www.hettich.com)

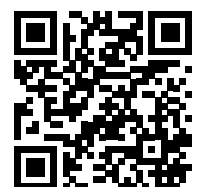

[www.hettich.com/short/a5dc50](http://www.hettich.com/short/a5dc50)



# Cadro frame system

## ► Summary



### Base

Basic profiles, sliding door profiles, drawer profiles, solutions for hinged doors 10 - 17

Connecting nodes 18 - 20

Mounting and accessories 21 - 23



### Assembly aids

24

### eShop

# Cadro frame system

► This is how the system works

## Base profile

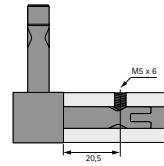
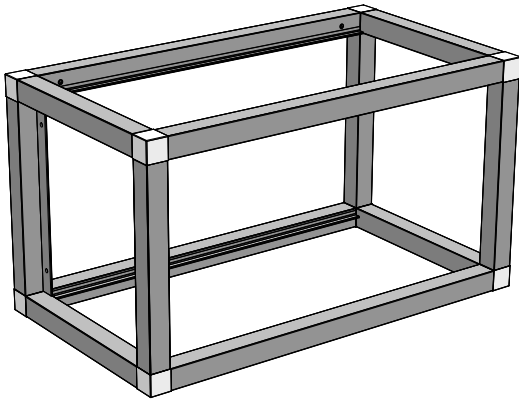

The Cadro frame system consists of various profiles that are connected together with connecting nodes. M5 x 6 mm grub screws are screwed into the connecting nodes for optimum security and stability. For this purpose, a 4.5 mm drill bit for metal is used to drill one hole per connecting arm at a defined distance from the end profile. The Cadro assembly aid (see page 33) can be used to drill the holes for a precise fit.

The Cadro aluminium profiles can be cut to any chosen size. Please note: we recommend fitting a maximum profile length of 1200 mm. Determining the profile length is as easy as this: all nodes have an external dimension of 18.5 x 18.5 mm. For each node, this must be subtracted from the outer dimensions of the furniture as to obtain a profile in the exact cut size. For example, 2 nodes and an outer dimension of 600 mm produce the following size: outer dimension: 600 mm, 2 x nodes: - 37 mm, profile size: 563 mm



Profiles for shelves, bottom panels or sides  
-> Page 10-11



Connecting nodes  
-> Page 18 - 20



Grub screws and other accessories  
-> Page 20



The Cadro range is available in matt black

## Other profiles



Profiles for sliding doors  
-> Page 12 - 13

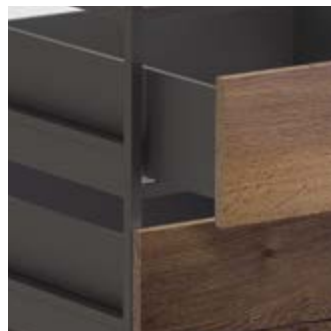

Profiles for drawers  
-> Page 14 - 15



Solutions for hinged doors  
-> Page 16



# Cadro frame system

## ► Shelf units, sides, surfaces

### Shelves - on their own or in combination with existing furniture



A wide range of attachment solutions are available for mounting Cadro shelf units on the wall --> page 22 - 23

Please observe the following load capacities for shelf modules:  
Shelf module W 600mm x D 250mm x H up to 450mm: 8.5 kg per level.  
Shelf module W 900mm x D 250mm x H up to 450mm: 12.5 kg per level.  
Shelf module W 1200mm x D 250mm x H up to 450mm: 16.5 kg per level.

The maximum recommended shelf width is 1200 mm.  
When using shelf units in a depth of greater than 250mm, the maximum load capacity must be checked by the installer on a case by case basis.

Want to combine the Cadro shelf unit with an existing furniture element? You will find the answer here --> Page 21



### Other profiles



Side or corner profiles  
-> Page 10 - 11



ball bearing locking fixture  
-> Page 11

Cadro provides a variety of options for closing off sides and surfaces of a furniture element.



Another option for mounting side panels is to use eccentric systems, such as our VB 35. The eccentric system solution is only visible from one side so as not to spoil the aesthetic appeal of the furniture element. Channels are routed in the chosen side panels in line with the eccentric system dimensions. The holes for the dowels are now drilled on the opposite profile sides.

# Cadro frame system

- ▶ Base
- ▶ Profiles

## Base profile

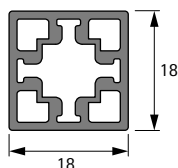
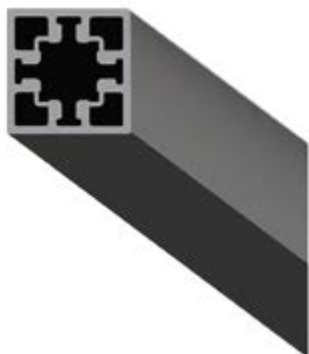

- ▶ Basic profile, e.g. for use as vertical stay in shelf units
- ▶ Length 3000 mm, can be cut to length
- ▶ Aluminium

Order no. / Colour	PU
Matt black	
<b>9 298 780</b>	1 ea.

## Shelf profile

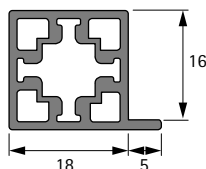

- ▶ For mounting 16 mm shelves
- ▶ Length 3000 mm, can be cut to length
- ▶ Aluminium

Order no. / Colour	PU
Matt black	
<b>9 298 792</b>	1 ea.

## Side / shelf profile for screwing on

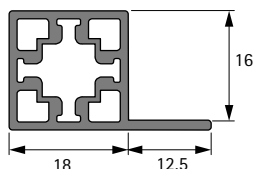

- ▶ For screw mounting 16 mm shelves
- ▶ Length 3000 mm, can be cut to length
- ▶ Aluminium

Order no. / Colour	PU
Matt black	
<b>9 298 796</b>	1 ea.

## Glass shelf profile / side / shelf profile, grooved

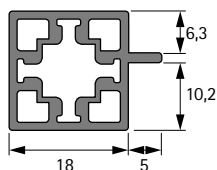
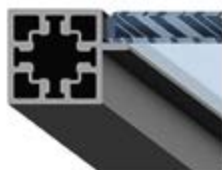

- ▶ For fitting 6 mm glass shelves or installing 16 mm grooved wooden shelves
- ▶ Length 3000 mm, can be cut to length
- ▶ Aluminium

Order no. / Colour	PU
Matt black	
<b>9 298 794</b>	1 ea.



# Cadro frame system

- ▶ Base
- ▶ Profiles, ball bearing locking fixture, cover caps

## Corner profile for screwing on

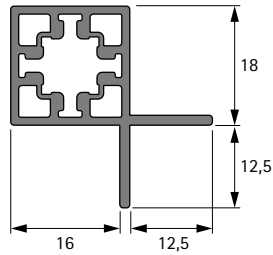

- ▶ For screw mounting 16 mm shelves
- ▶ Length 3000 mm, can be cut to length
- ▶ Aluminium

Order no. / Colour	PU
Matt black	
9 303 886	1 ea.

## ball bearing locking fixture

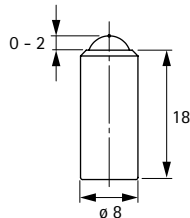

- ▶ Alternative way of fitting sides and rear panels
- ▶ For recessing into side / rear panel
- ▶ With integrated metal spring
- ▶ The threaded pin holes (node attachment) can be used for clipping into the Cadro profile
- ▶ **Important note: not suitable for load bearing walls or floors!**
- ▶ stainless steel

Order no.	PU
9 298 863	4 ea.

## Profile cover cap, standard

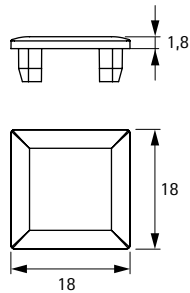
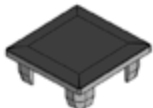

- ▶ For fitting onto the profile end
- ▶ Plastic

Order no. / Colour	PU
black	
9 298 849	10 ea.

## Slim profile cover cap

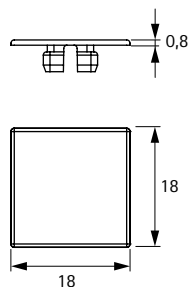

- ▶ For fitting onto the profile end
- ▶ Plastic

Order no. / Colour	PU
black	
9 298 851	10 ea.

# Cadro frame system

- ▶ Base
- ▶ Connecting sliding doors



Cadro is much more than a frame system. Combining it with the Hettich SlideLine M sliding door system produces new furniture creations in a perfect symbiosis of design and functionality. The Cadro sliding door profiles provide the capability of screwing the cabinet shelves directly into place while also serving as a runner and guide profile. Here, sliding doors can be installed as overlay or inset doors.

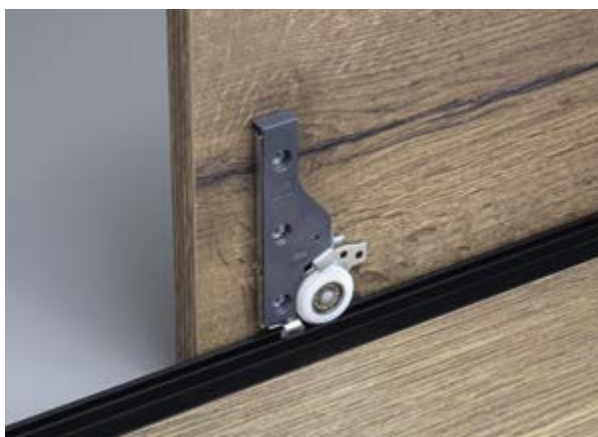

Cadro Slide Line M sliding door profiles for overlay doors



Cadro Slide Line M sliding door profiles for inset doors

# Cadro frame system

- ▶ Base
- ▶ SlideLine M sliding door profiles

## Sliding door profile, inset, top

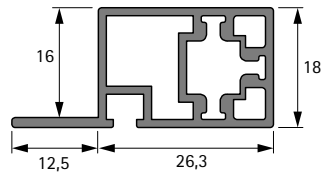

- ▶ Top panel profile for flush fitting sliding door solutions
- ▶ Suitable for SlideLine M fitting
- ▶ For 16 mm panels, screw on type
- ▶ Length 3000 mm, can be cut to length
- ▶ Aluminium

Order no. / Colour	PU
<b>Matt black</b>	
<b>9 298 802</b>	1 ea.

## Sliding door profile, inset, bottom

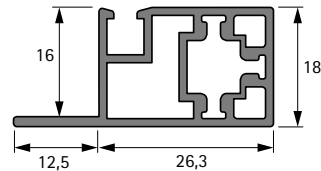

- ▶ Bottom panel profile for flush fitting sliding door solutions
- ▶ Suitable for SlideLine M fitting
- ▶ For 16 mm panels, screw on type
- ▶ Length 3000 mm, can be cut to length
- ▶ Aluminium

Order no. / Colour	PU
<b>Matt black</b>	
<b>9 298 804</b>	1 ea.

## Sliding door profile, overlay, top

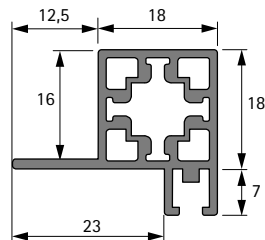

- ▶ Top panel profile for overlay sliding door solutions
- ▶ Suitable for SlideLine M fitting
- ▶ For 16 mm panels, screw on type
- ▶ Length 3000 mm, can be cut to length
- ▶ Aluminium

Order no. / Colour	PU
<b>Matt black</b>	
<b>9 298 798</b>	1 ea.

## Sliding door profile, overlay, bottom

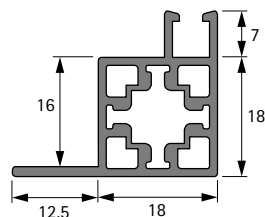

- ▶ Bottom panel profile for overlay sliding door solutions
- ▶ Suitable for SlideLine M fitting
- ▶ For 16 mm panels, screw on type
- ▶ Length 3000 mm, can be cut to length
- ▶ Aluminium

Order no. / Colour	PU
<b>Matt black</b>	
<b>9 298 800</b>	1 ea.

## Cadro frame system

- ▶ Base
- ▶ AvanTech YOU / Actro YOU / Actro 5D drawer profiles



The innovative AvanTech YOU drawer system sets new standards in drawers thanks to its pure design and elegant look. In combination with the Cadro frame system, this produces countless options. AvanTech YOU drawers are easy to fit on the Cadro drawer profile. A small groove in the profile makes sure that the Actro YOU runner is mounted for an exact fit. The runner's cabinet body rail is completely hidden from view once the matching cover profiles are in place. This means it is even possible to produce open shelf unit designs with drawer elements for a visually appealing look with practical functionality. Alternatively, wooden drawers can also be used with the Actro 5D runner.



# Cadro frame system

- ▶ Base
- ▶ AvanTech YOU / Actro YOU / Actro 5D drawer profiles

## AvanTech YOU / Actro YOU / Actro 5D drawer profile

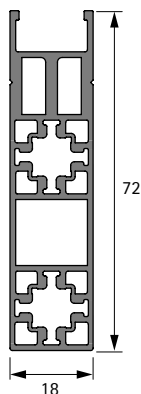

- ▶ For adapting the AvanTech YOU drawer system in combination with the Actro YOU runner or a wooden drawer in combination with the Actro 5D runner
- ▶ Max. recommended nominal length (NL) 600 mm
- ▶ Length 3000 mm, can be cut to length
- ▶ Aluminium

Order no. / Colour	PU
<b>Matt black</b>	
<b>9 298 806</b>	1 ea.

## L profile, AvanTech YOU / Actro YOU / Actro 5D

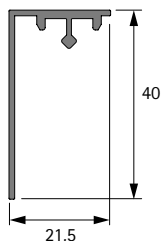

- ▶ L profile for concealing Actro YOU / Actro 5D runner on one side
- ▶ The cover profile must be attached to the drawer profile, order no. 9 298 806 / 9 298 807
- ▶ Clip for mounting the cover profile, order no. 9 304 915, please order separately
- ▶ Length 3000 mm, can be cut to length
- ▶ Aluminium

Order no. / Colour	PU
<b>Matt black</b>	
<b>9 298 808</b>	1 ea.

## U profile, AvanTech YOU / Actro YOU / Actro 5D

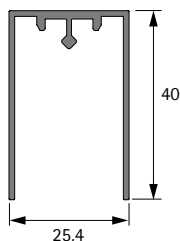

- ▶ U profile for concealing Actro YOU / Actro 5D runner on both sides
- ▶ The cover profile must be attached to the drawer profile, order no. 9 298 806 / 9 298 807
- ▶ Clip for mounting the cover profile, order no. 9 304 915, please order separately
- ▶ Length 3000 mm, can be cut to length
- ▶ Aluminium

Order no. / Colour	PU
<b>Matt black</b>	
<b>9 298 810</b>	1 ea.

## Clip for AvanTech YOU / Actro YOU / Actro 5D cover profiles

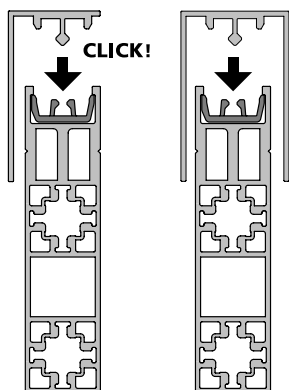

- ▶ Clip for mounting the L and U cover profiles
- ▶ The clip simply fits into the top of the basic drawer profile
- ▶ We recommend using 3 clips on each drawer side
- ▶ Plastic, black

Order no.	PU
<b>9 304 915</b>	30 ea.

# Cadro frame system

## ► Hinge connection

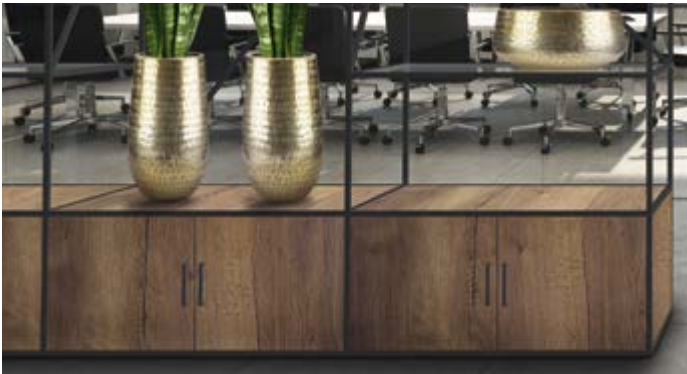

Hettich Sensys hinges provide a further option for creating your very own individualised piece of furniture. Besides fitting inset doors within the frame, it is also easily possible to mount overlay doors. This also makes it possible to construct furniture elements that are completely closed off.



### Inset doors

Sensys hinges for inset doors (base B-4) in combination with Sensys cross mounting plates. The mounting plate to select depends on the specific application, e.g. chosen type of reveal.

Example: 1 mm reveal / cup distance C = 4 mm

-> Sensys 110° hinge for inset doors + cross mounting plate distance 3 mm.



### Overlay doors

Sensys hinges for overlay doors (base 12.5 mm) in combination with Sensys cross mounting plates for screwing on (attachment with  $\varnothing 4.5 \times 18$  mm countersunk screws). The mounting plate to select depends on the specific application, e.g. chosen type of overlay.

Example: 17 mm overlay / 1 mm reveal / cup distance C = 4.5 mm

-> Sensys 110° hinge for overlay doors + cross mounting plate distance 0 mm.

It may be necessary to line the mounting plates with backing material.

## Door mounting for hinged doors

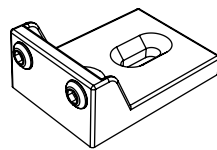

- Prevents hinged doors from going in too far
- For screwing to the cabinet body side panel / top panel
- Plastic

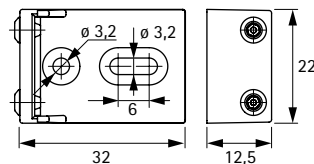

Order no. / colour	PU
black	
9 303 883	2 ea.



# Cadro frame system

- ▶ Basis
- ▶ handles and knobs

## Handle, Cadro

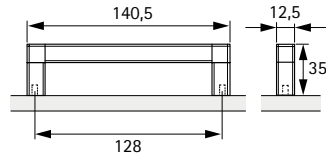

- ▶ Drill hole spacing 128 mm
- ▶ Die-cast zinc

Order no. / Finish Matt black	PU
9 298 816	1/50 ea.

## Knob, Cadria

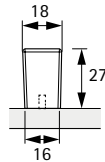

- ▶ Die-cast zinc

Order no. / Finish Matt black	PU
9 303 938	1/50 ea.

# Cadro frame system

- ▶ Base
- ▶ Connecting nodes

## Connecting node, 2-way



- ▶ For connecting Cadro profiles
- ▶ One Cadro threaded stud per node arm is required for securing it in the profile, order no. 9 298 859 / 9 298 860, please order separately
- ▶ Die-cast zinc

Order no. / Colour	PU
Matt black	
9 298 821	1 ea.

## Connecting node, 2-way, with height adjustment capability



- ▶ For connecting Cadro profiles
- ▶ Including leg, height 4 mm, height adjustable up to 5 mm
- ▶ One Cadro threaded stud per node arm is required for securing it in the profile, order no. 9 298 859 / 9 298 860, please order separately
- ▶ Max. load capacity 50 kg / leg
- ▶ Die-cast zinc

Order no. / Colour	PU
Matt black	
9 298 823	1 ea.

## Connecting node, 3-way, 2D

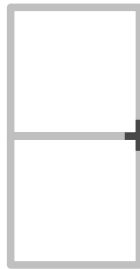

- ▶ For connecting Cadro profiles
- ▶ One Cadro threaded stud per node arm is required for securing it in the profile, order no. 9 298 859 / 9 298 860, please order separately
- ▶ Die-cast zinc

Order no. / Colour	PU
Matt black	
9 298 825	1 ea.

## Connecting node, 3-way, 2D, with height adjustment capability

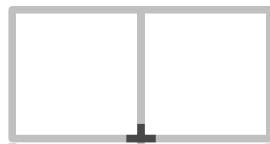

- ▶ For connecting Cadro profiles
- ▶ Including leg, height 4 mm, height adjustable up to 5 mm
- ▶ One Cadro threaded stud per node arm is required for securing it in the profile, order no. 9 298 859 / 9 298 860, please order separately
- ▶ Max. load capacity 50 kg / leg
- ▶ Die-cast zinc

Order no. / Colour	PU
Matt black	
9 298 827	1 ea.

# Cadro frame system

- ▶ Base
- ▶ Connecting nodes

## Connecting node, 3-way, 3D

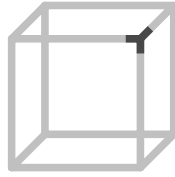

- ▶ For connecting Cadro profiles
- ▶ One Cadro threaded stud per node arm is required for securing it in the profile, order no. 9 298 859 / 9 298 860, please order separately
- ▶ Die-cast zinc

Order no. / Colour	PU
Matt black	
9 298 829	1 ea.

## Connecting node, 3-way, 3D, with height adjustment capability

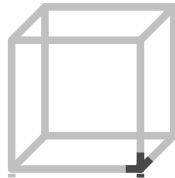

- ▶ For connecting Cadro profiles
- ▶ Including leg, height 4 mm, height adjustable up to 5 mm
- ▶ One Cadro threaded stud per node arm is required for securing it in the profile, order no. 9 298 859 / 9 298 860, please order separately
- ▶ Max. load capacity 50 kg / leg
- ▶ Die-cast zinc

Order no. / Colour	PU
Matt black	
9 298 831	1 ea.

## Connecting node, 4-way

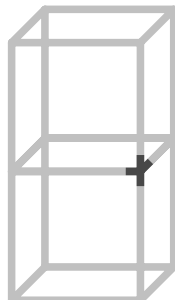

- ▶ For connecting Cadro profiles
- ▶ One Cadro threaded stud per node arm is required for securing it in the profile, order no. 9 298 859 / 9 298 860, please order separately
- ▶ Die-cast zinc

Order no. / Colour	PU
Matt black	
9 298 833	1 ea.

## Connecting node, 4-way, with height adjustment capability

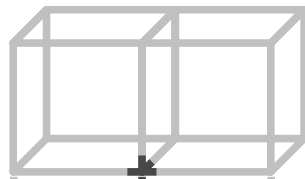

- ▶ For connecting Cadro profiles
- ▶ Including leg, height 4 mm, height adjustable up to 5 mm
- ▶ One Cadro threaded stud per node arm is required for securing it in the profile, order no. 9 298 859 / 9 298 860, please order separately
- ▶ Max. load capacity 50 kg / leg
- ▶ Die-cast zinc

Order no. / Colour	PU
Matt black	
9 298 835	1 ea.

# Cadro frame system

- ▶ Base
- ▶ Connecting nodes, accessories

## Connecting node, 5-way

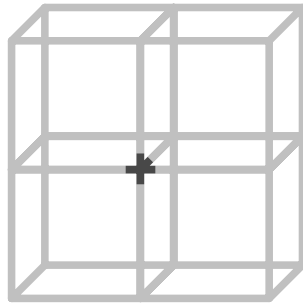

- ▶ For connecting Cadro profiles
- ▶ One Cadro threaded stud per node arm is required for securing it in the profile, order no. 9 298 859 / 9 298 860, please order separately
- ▶ Die-cast zinc

<b>Order no. / Colour</b> Matt black	PU
<b>9 298 837</b>	1 ea.

## Threaded stud, M5 x 6 mm

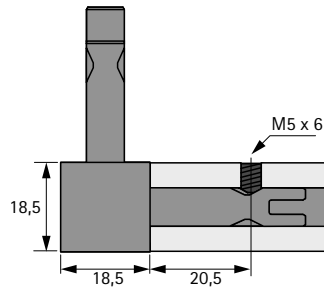

- ▶ Self tapping grub screw, M5 x 6 mm, DIN 913
- ▶ For securely connecting profiles and connecting nodes without any gaps
- ▶ The threaded studs fit into the tapered depressions in the node arms
- ▶ We recommend using a 4.5 mm metal drill bit for drilling the hole required in the profile
- ▶ 0.8 - 1 Nm torque when using a cordless screwdriver
- ▶ Steel

<b>Order no. / Colour</b> Matt black	PU
<b>9 298 859</b>	25 ea.

## Cover cap for M5 threaded stud

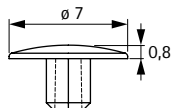

- ▶ For covering M5 threaded studs screwed into the profile
- ▶ Plastic

<b>Order no. / Colour</b> black	PU
<b>9 298 856</b>	25 ea.

## Dummy plug

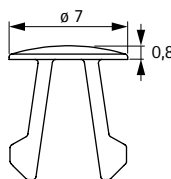

- ▶ Cover clip for concealing ø 4 - 6 mm drill holes in the profile
- ▶ Plastic

<b>Order no.</b>	PU
<b>9 298 858</b>	25 ea.

# Cadro frame system

- ▶ Base
- ▶ Wall / floor attachment

## Universal connecting node



- ▶ For connecting up to six Cadro profiles
- ▶ One pin, including M5 cylinder head screw, order no. 9 303 956, is required for each profile being connected
- ▶ The pin must be screwed together with the universal connecting node
- ▶ One Cadro threaded stud per pin is required for securing it in the profile, prod. no. 9 298 859 / 9 298 860, please order separately
- ▶ Connecting nodes and pin: die-cast zinc

Article	Order no.	PU
Universal connecting node, matt black	<b>9 303 954</b>	1 ea.
Pin, including cylinder head screw, galvanised	<b>9 303 956</b>	1 ea.

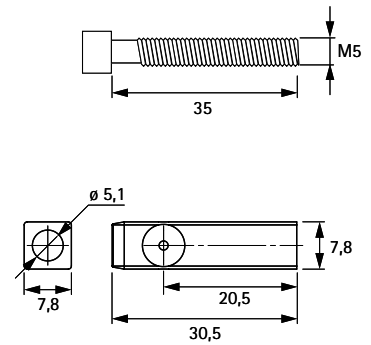
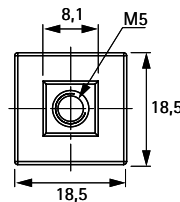
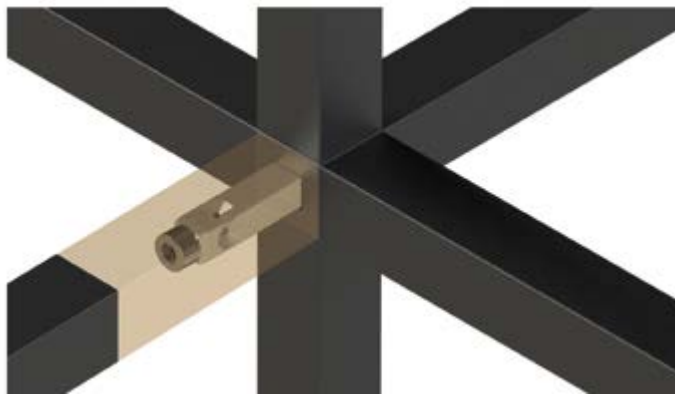

## Fixing sleeve



- ▶ For connecting the Cadro system to existing furniture elements
- ▶ The fixing sleeve must be screwed to the existing furniture element, the predrilled Cadro profile is then positioned and secured by grub screw
- ▶ One Cadro threaded stud per fixing sleeve for securing it in the profile, prod. no. 9 298 859 / 9 298 860, please order separately
- ▶ Fixing screws are not included as they must suit the furniture element concerned
- ▶ Used in the proper way, four fixing sleeves provide a maximum load capacity of 30 kg when hanging a Cadro shelf unit on a cabinet.
- ▶ stainless steel

Order no.	PU
<b>9 298 848</b>	2 set

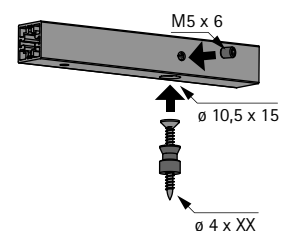
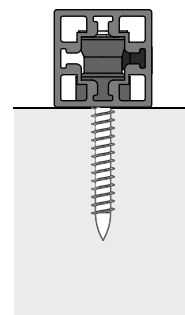
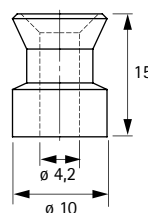
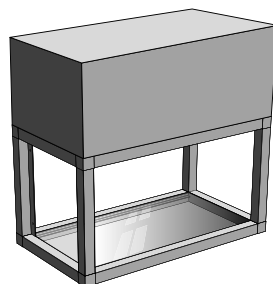
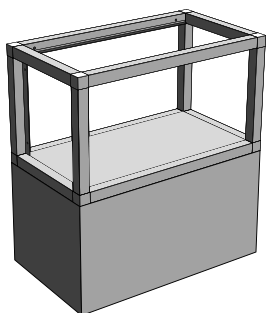

# Cadro frame system

- ▶ Base
- ▶ Wall / floor attachment

## Wall mount, concealed



- ▶ Concealed wall mount for Cadro profiles
- ▶ The Cadro profiles must be routed out and predrilled
- ▶ Attach the mount to the wall, then hook on the furniture elements and fix in place
- ▶ Precision adjustment capability in height after fitting
- ▶ Max. load capacity 60 kg per set
- ▶ Please note: the mounting hardware provided is suitable for usual, firm brickwork. Its suitability must be verified on site

### Set comprises:

- ▶ 2 wall mounts, galvanised steel
- ▶ 2 flat head screws, 4 x 38 mm
- ▶ 2 plastic wall plugs, 7 x 35 mm
- ▶ 4 threaded studs, M5 x 6 mm, in 2 surface finishes

Order no.	PU
9 298 847	1 set

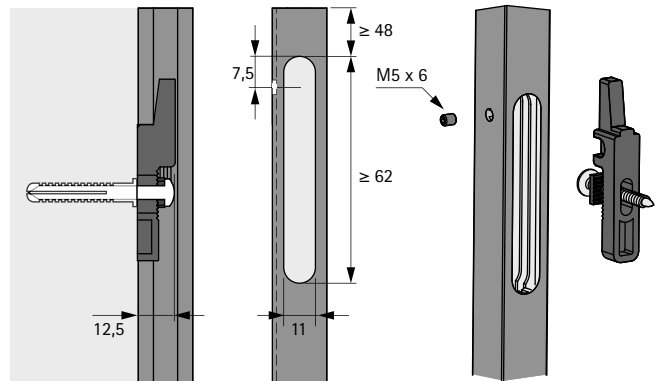
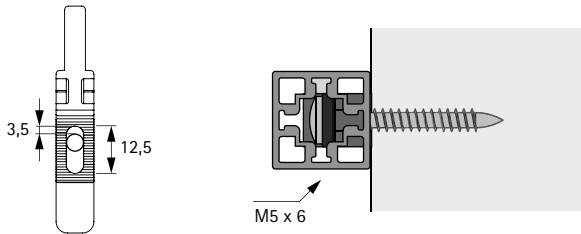

## Cover cap, Ø 10 mm, for direct attachment to wall



- ▶ To cover a Ø 10 mm hole when fixing the Cadro profile directly to the wall
- ▶ A Ø 4.5 mm through hole must be drilled at the centre of Cadro profile before drilling a further Ø 10 x 12 mm hole
- ▶ The profile must be fixed directly to the wall with a Ø 4 mm panhead screw; fixing screw not included
- ▶ The profile hole is concealed by the cover cap
- ▶ Plastic

Order no. / Colour	PU
black	
9 298 854	20 ea.

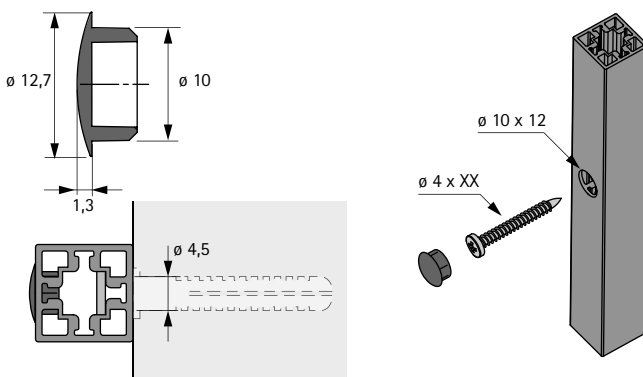

# Cadro frame system

- ▶ Base
- ▶ Wall / floor attachment

## Wall / floor attachment, 55 x 55 mm



- ▶ For screwing onto the wall or floor
- ▶ Outer dimensions including cover 55 x 55 mm
- ▶ One Cadro threaded stud is required for fixing in the profile, prod. no. 9 298 859 / 9 298 860, please order separately
- ▶ Mounting hardware is not included as it must suit the type of wall concerned
- ▶ Loading capacity 25 kg / set

Set comprises:

- ▶ 1 base, die-cast zinc
- ▶ 1 cover cap, die-cast zinc
- ▶ 1 grub screw, M4 x 6 mm, for attaching the cover cap, steel

Order no. / Colour	PU
<b>Matt black</b>	
<b>9 303 940</b>	1 set

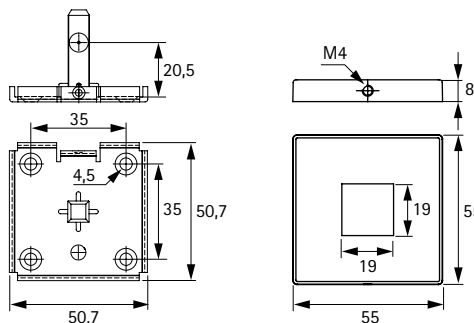

## Wall / floor attachment, 18 x 18 mm



- ▶ Concealed wall / floor attachment
- ▶ For screwing onto the wall or floor
- ▶ Outer dimensions 18,5 x 18,5 mm
- ▶ One Cadro threaded stud per wall / floor mount is required for securing it in the profile, prod. no. 9 298 859 / 9 298 860, please order separately
- ▶ Mounting hardware is not included as it must suit the type of wall concerned
- ▶ Load capacity 25 kg / ea.
- ▶ Die-cast zinc

Order no. / Colour	PU
<b>Matt black</b>	
<b>9 303 942</b>	1 ea.

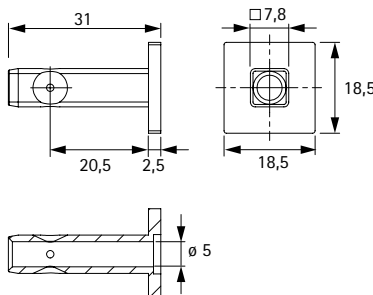

# Cadro frame system

## ► Assembly aids

### Cadro installation aid



- Jig for achieving perfectly fitting drill hole and threaded hole for the Cadro base and shelf profiles
- With movable fixing stop for fitting profiles
- We recommend fixing the installation aid on a pillar drill
- Optional upgrade with add on set for sliding door profiles, order no. 9 298 866
- Plastic, white

Order no.	PU
<b>9 298 865</b>	1 ea.

### Add on set, installation aid for sliding door profiles



- Add-on set for achieving perfectly fitting drill hole and threaded hole for the Cadro sliding door profiles
- Suitable for Cadro installation aid, prod. no. 9 298 865, please order separately
- Plastic, white

Set comprises:

- 2 add on elements for sliding door profiles, inset
- 2 add on elements for sliding door profiles, overlay

Order no.	PU
<b>9 298 866</b>	1 set





Learn more about the Hettich family-owned  
company and get to know us better!



Order no. 9 309 153  
2101-025\_Cadro\_10/21\_HM/en

Technik für Möbel

